

IVORIS



MAKE SURE
IT'S RAK





MAKE SURE IT'S RAK

TABLE OF CONTENTS

En This catalogue is the working instrument of all RAK Porcelain distribution channels. The availability of certain products may vary depending on countries. Please check the availability of the products you would like to purchase with the distributor/importer of RAK Porcelain in your area. Current prices apply.

Es Este catálogo es la herramienta de trabajo de todos los circuitos de distribución de RAK Porcelain. La disponibilidad de determinados productos puede variar en función de los países. Les rogamos que comprueben, con el distribuidor/importador de RAK Porcelain de su región, la disponibilidad de los productos que deseen adquirir. Los precios actuales sirven de referencia.

Fr Ce catalogue est l'outil de travail de tous les circuits de distribution RAK Porcelaine. La disponibilité de certains produits pourrait varier selon les pays. Veuillez vérifier auprès du distributeur/importateur de RAK Porcelaine de votre région, la disponibilité des produits que vous aimeriez acquérir. Les tarifs actuels font référence.

It Il presente catalogo rappresenta lo strumento di lavoro di tutti i circuiti di distribuzione di RAK Porcelain. La disponibilità di alcuni prodotti può variare in base al paese. Vi preghiamo pertanto di verificare la disponibilità dei prodotti che desiderate acquistare presso il distributore o l'importatore RAK Porcelain e di fare riferimento alle tariffe attuali.

De Dieser Katalog ist die Arbeitsgrundlage für sämtliche Vertriebstätigkeiten von RAK Porzellan. Die Verfügbarkeit einiger Produkte kann je nach Land variieren. Bitte prüfen Sie bei dem für Ihre Region zuständigen Vertriebspartner bzw. Importeur von RAK Porzellan, ob die von Ihnen gewünschten Produkte verfügbar sind. Maßgeblich ist die aktuelle Preisliste.

4	RAK Porcelain	136	Massilia
6	Make sure it's RAK	140	Mazza
7	Ivoris	144	Metropolis
8	5 Years anti-Chip guarantee	148	Minimax
10	Quality	162	Nabur
12	Product care	166	Nano
14	Segmentation	172	Nordic
18	Shapes	178	Pixel
20	Plate specifications	184	Rondo
24	Designers	190	Samba
30	Allspice	194	Ska
38	Anna	200	Supreme NEW
44	Aurea	204	White Gold
52	B. Concept	210	Wonder NEW
56	Banquet	214	Small & smart
66	Barista	226	Cups & saucers
70	Blossom NEW		
74	Bouquet NEW		
78	Buffet		
86	Choice NEW		
90	Classic Gourmet		
96	Favourite NEW		
100	Fine Dine		
106	Giro		
112	Hospital & Healthcare		
116	Lace NEW		
120	Leon		
126	Lyra		
132	Marea		

RAK PORCELAIN,
A TALE OF A THOUSAND
AND ONE WONDERS



En

RAK Porcelain acts as a partner to leaders in all hospitality categories in search of excellence with those that are convinced that the tableware adds value to their table and to their guest experience.

If one of our collections sets off a culinary work perfectly, or if the design of a table service inspires the preparation of the dish, our mission has been successful. The table then becomes an art ...to taste... practical in use and highly aesthetic, this perfectly exemplifies RAK Porcelain's passion at work.

Fr

RAK Porcelaine est le partenaire des leaders de la gastronomie, constamment en quête de l'excellence dans leur catégorie. Comme eux, nous sommes conscients de la valeur ajoutée des arts de la table auprès de la clientèle.

Lorsque l'une de nos collections encadre une œuvre culinaire à merveille, ou lorsque le design d'un service de table inspire la préparation des mets, notre mission est accomplie. La table devient alors véritablement un art... qui se déguste. Proposer aux chefs une porcelaine à la fois pratique d'utilisation et esthétique, voilà très exactement le résultat de notre passion.

De

RAK Porzellan ist Partner der führenden gastronomischen Trendsetter, die wie wir, von der Wertschöpfung der Tischkultur für die Gastronomie überzeugt sind. „Das Auge isst mit“! Wenn eine unserer Kollektionen ein kulinarisches Meisterwerk einrahmt oder unser Design die Präsentation der Gerichte inspiriert, haben wir unsere Mission erfüllt. Die gastronomische Tafel wird dann tatsächlich zur „essbaren Kunst“.

RAK Porzellan bietet den kreativen Küchenchefs die Möglichkeit zu außergewöhnlichen Präsentationen. Funktionalität, geprägt durch eine erprobte Ästhetik, die sich nach Kundenwunsch anpassen lässt, ist Kerninhalt unserer Leidenschaft.

Es

RAK Porcelain actúa como un socio indiscutible de los líderes de la hostelería en todas sus categorías a través de la búsqueda constante de la excelencia. Estamos humildemente convencidos de que nuestras vajillas pueden aportar un valor añadido a la gastronomía y a la experiencia culinaria de ustedes y de sus clientes.

Antes incluso que por el paladar, el entusiasmo entra por los ojos. Cuando una de nuestras colecciones enmarca una obra culinaria de maravilla, o cuando el diseño de un servicio de mesa inspira la preparación de los platos, podemos considerar alcanzada nuestra meta. No es sino entonces cuando la mesa adquiere verdaderamente el estatus de arte, lo que expresa y representa perfectamente la pasión de RAK Porcelain por el trabajo bien hecho.

It

RAK Porcelain è il partner di varie aziende leader nel campo della gastronomia costantemente alla ricerca dell'eccellenza nella propria categoria. Come loro, anche noi siamo coscienti del valore aggiunto dell'arte della tavola presso la clientela.

Quando una delle nostre collezioni incornicia alla perfezione un'opera culinaria o quando il design di un servizio da tavola ispira la preparazione dei cibi sappiamo di avere compiuto la nostra missione. La tavola diventa così vera e propria arte... tutta da gustare. La nostra passione: Proporre agli chef una porcellana che offra al contempo praticità di utilizzo e grande valore estetico.

MAKE SURE IT'S RAK



En Cutting-edge technology

Using cutting-edge technology our collections are designed to withstand intensive use as well as mechanical and thermal shocks inherent in the profession. By selecting raw materials of the highest quality, our products stand up over time to heat of traditional or microwave ovens, while retaining the brilliance of their enamel and the fineness of their decorations.

An optimised worldwide distribution

Linked to a solid worldwide distribution structure, we rely on a network of experts and operators specialising in tableware to serve you wherever and whenever you desire. We insist on providing you with very short lead times.

Fr Une technologie de pointe

Nos collections sont élaborées grâce à une technologie de pointe pour résister aux usages intensifs ainsi qu'aux chocs thermiques et mécaniques inhérents à la profession. En sélectionnant des matières premières de la plus grande qualité, nos produits résistent sur la durée à la chaleur des fours traditionnels ou micro-ondes, tout en conservant l'éclat de leur émail et la finesse de leurs décorations.

Une distribution mondiale optimisée

Liée à une solide structure de distribution au niveau mondial, nous nous appuyons sur un réseau d'experts et d'opérateurs spécialisés dans les arts de la table afin de vous servir où et quand vous le désirez. Nous tenons à vous assurer des délais d'approvisionnement très courts.

De Spitzentechnologie

Unsere Kollektionen sind aufgrund einer hochentwickelten Technologie äußerst widerstandsfähig gegenüber intensiver thermischer und mechanischer Beanspruchung. Durch die Auswahl qualitativ hochwertiger Rohstoffe sind unsere Produkte dauerhaft hitzebeständig (gleichmaßen offen- wie mikrowellengeeignet) – ohne Beschädigungen der Glasur bzw. Einbußen beim Dekor.

Optimierter weltweiter Vertrieb

Unser weltweites Vertriebsnetzwerk besteht aus Experten und Spezialisten der Tischkultur, die Ihnen gern mit Rat und Tat zur Seite stehen. Bei uns können Sie sich auf sehr kurze Lieferzeiten verlassen.

Es Una tecnología puntera

Nuestras colecciones están elaboradas con tecnología puntera para lograr que resistan a los usos intensivos y a los choques térmicos y mecánicos inherentes a la profesión. Gracias a unas materias primas de la máxima calidad, nuestros productos soportan a largo plazo el calor de los hornos tradicionales o de los microondas, sin perder el brillo de su esmalte y la delicadeza de sus decoraciones.

Distribución mundial optimizada

La distribución, basada en una sólida estructura a escala mundial, cuenta con el apoyo de una red de expertos y operadores especializados en las artes de la mesa que nos permite prestarle servicio en todas partes y en cualquier momento. Nuestro empeño es asegurar unos plazos de suministro muy ajustados.

It Una tecnologia all'avanguardia

Le nostre collezioni vengono sviluppate grazie a una tecnologia innovativa che assicura la resistenza all'utilizzo intensivo, nonché agli sbalzi termici e meccanici legati all'esercizio della professione. Realizzati con materie prime accuratamente selezionate per offrire la massima qualità, i nostri prodotti resistono al calore dei forni tradizionali e a microonde, conservando intatta la lucentezza dello smalto e la finezza delle decorazioni.

Una distribuzione mondiale ottimizzata

Essendo legati a una solida struttura di distribuzione a livello mondiale, possiamo contare su una vasta rete di esperti e operatori specializzati per servirvi ovunque e in qualsiasi momento. Desideriamo garantirvi dei tempi di approvvigionamento estremamente ridotti.

En

Ivoris porcelain sets the table in warm white. With a shade close to ivory, this porcelain provides ultimate resistance against the inevitable knocks in the kitchen or dining room, and to chemical aggression due to maintenance and contact with food products. The high level of alumina strengthens its mechanical resistance. This quality is also due to the selection of the best raw materials, used notably for the vitrification of glazes.

The enamel is exceptionally resistant to scratches and cutlery marks, and offers admirable longevity to its complete range, which includes more than forty series. The variety of these series offers infinite "mix and match" possibilities, to diversify its pieces and to combine series, protected by RAK Porcelain's quality standards.

Fr

La porcelaine Ivoris habille les tables d'un blanc chaud. Avec une teinte proche de l'ivoire, cette porcelaine possède une résistance ultime face aux chocs inévitables en cuisine ou en salle, et aux agressions chimiques dues à l'entretien et au contact avec les produits alimentaires. Le taux élevé d'alumine renforce la résistance mécanique. Cette qualité provient aussi de la sélection des meilleures matières premières, employées notamment pour la vitrification des glaçures.

L'email résiste de façon exceptionnelle aux rayures, marques produites par les couverts et offre une longévité admirable à sa gamme complète qui comprend plus de quarante séries. La variété de ces séries offre des possibilités infinies de « mix and match » pour diversifier ses pièces et mélanges les séries, en conservant le gage de la qualité RAK Porcelaine.

De

Das Porzellan Ivoris schenkt Ihrer Tafel einen warmweißen Akzent. Dieses fast elfenbeinfarbige Porzellan ist von besonders hoher Festigkeit und schützt so vor unvermeidlichen Stößen und chemischen Einflüssen bei der Reinigung und beim Kontakt mit Lebensmitteln in Küche oder Restaurant. Der hohe Aluminiumgehalt verstärkt die Bruchfestigkeit. Diese hohe Qualität entsteht auch durch die Auswahl der besten Rohstoffe, die insbesondere für die Vitrifizierung der Glasuren verwendet werden.

Diese sind außergewöhnlich widerstandsfähig gegen Kratzer und Besteckspuren und verschaffen dem kompletten, mehr als 40 Serien umfassenden Sortiment, erstaunliche Langlebigkeit. Die Vielfalt der Serien erlaubt unendlich viele Kombinationsmöglichkeiten für eine abwechslungsreiche Zusammenstellung der Teile und Serien bei gleichzeitiger Gewährleistung der verlässlichen Qualität von RAK Porzellan.

Es

La porcelana Ivoris cubre la mesa de un blanco cálido. Con un tono próximo al marfil, esta porcelana presenta una resistencia definitiva ante golpes inevitables en la cocina o en la sala, así como a las agresiones químicas debidas al mantenimiento y al contacto con los productos alimentarios. La elevada tasa de aluminio refuerza la resistencia mecánica. Esta calidad procede también de la selección de las mejores materias primas, empleadas en especial para la vitrificación de los vidriados.

El esmalte resiste de modo excepcional a las rayaduras y a las marcas producidas por los cubiertos, y ofrece una admirable durabilidad a su gama completa, que abarca más de cuarenta series. La variedad de estas series ofrece posibilidades infinitas de "mix and match" para diversificar sus piezas y mezclar las series, conservando el sello de calidad de RAK Porcelain.

It

La porcellana Ivoris veste la tavola di un bianco caldo. Con una tonalità vicina all'avorio, questa porcellana possiede una resistenza totale agli urti, inevitabili in cucina e in sala, e alle aggressioni chimiche dovute alla manutenzione e al contatto con prodotti alimentari. Il tasso elevato di alluminio rafforza la resistenza meccanica. Questa qualità deriva anche dalla selezione delle migliori materie prime, utilizzate in particolare per la vetrificazione degli smalti.

Lo smalto resiste in modo eccezionale a graffi e segni di posate e offre una longevità ammirevole in tutta la gamma, che comprende oltre quarante serie. La varietà di queste serie offre possibilità infinite di "mix and match" per diversificare i pezzi e mescolare le serie mantenendo la garanzia della qualità RAK Porcelain.



5 YEARS

ANTI-CHIP
GUARANTEE



En Product advantage

What makes the difference at RAK Porcelain?

Innovative tabletop collections ... dedicated to professionals, delivered with an unforgettable quality of service... that offer both unmatched artistic and practical levels of quality within the hospitality industry.

What creates excellence at RAK Porcelain?

Creation, inspiration, and especially the constant search for a better balance in the design of products for continuous and intensive use drives RAK Porcelain in its continual pursuit of excellence. Our mission is to improve the daily worries of all our ambassadors in the worldwide foodservice industry. All our collections are shaped for ease in handling, resistance to variations in temperature, and a superior overall strength to insure a long lasting product even within the harsh conditions of the hospitality industry.

We invite you to discover the results of our passion and expertise in the following pages.

Warranty

RAK Porcelain and its distribution networks offer you a limited warranty covering chipping for several collections (contact your dealer for more details). We will replace any of those items that have rim chips, on the condition that the complaint is addressed within 5 years from the date of purchase. This warranty is only valid for the normal use of the products. The warranty does not cover breakage or damage arising from misuse or non-ordinary use of our products.

Fr Avantage produit

Ce qui fait la différence chez RAK Porcelaine ?

Des collections novatrices dédiées aux professionnels, une proximité et une qualité de service qui nous tiennent à cœur.

Ce qui fait l'excellence ?

La création, l'inspiration, et surtout la recherche constante du meilleur équilibre dans la conception des produits sont étudiées pour une utilisation constante et intensive. Nous avons pour vocation de faciliter le quotidien des professionnels de l'hôtellerie et de la restauration. Aussi nos collections sont toutes façonnées pour une meilleure préhension, une résistance aux variations thermiques et une robustesse supérieure.

Nous vous invitons à découvrir le résultat de notre savoir-faire dans les pages qui suivent.

Garantie

RAK Porcelaine et ses réseaux de distribution vous offrent une garantie limitée couvrant les ébréchures sur plusieurs collections (prière de contacter votre revendeur pour de plus amples informations). Nous remplacerons tout article présentant des ébréchures sur le rebord, à condition que la réclamation nous soit adressée dans les 5 ans à compter de la date d'achat. Cette garantie est uniquement valable en cas d'utilisation normale des produits. La garantie ne couvre pas le bris ou les dommages résultant d'une utilisation abusive ou non-ordinaire de nos produits.

De Vorteile

Was unterscheidet RAK Porzellan?
Es sind die innovativen Kollektionen, die sich hervorragend miteinander kombinieren lassen und die ausgearbeiteten Konzepte für die Gastronomie, sowie die Garantie unserer Dienstleistung und deren Qualität, auf die wir großen Wert legen.

Worauf gründet unser Erfolg?

Die Kreation, die Inspiration, aber insbesondere die konstante Suche nach dem idealen Gleichgewicht zwischen Design und Funktion. RAK Porzellan greift zusätzlich auf eine außergewöhnliche Kompetenz in der Keramikfertigung zurück.

Wir laden Sie ein, auf den folgenden Seiten die Ergebnisse unseres Könnens zu entdecken.

Garantie

RAK Porzellan und seine Vertriebsstrukturen bieten Ihnen für mehrere Kollektionen eine eingeschränkte Garantie für Kantenabsplitterung (kontaktieren Sie Ihren Händler für weitere Details). Einzelne Artikel mit Kantenabsplitterung werden ersetzt, wenn die Beschwerde innerhalb von 5 Jahren ab dem Kaufdatum eingereicht wird. Diese Garantie gilt nur für den normalen Gebrauch der Produkte. Die Garantie erstreckt sich nicht auf Brüche oder Schäden, die durch Missbrauch oder nicht alltäglichen Gebrauch unserer Produkte entstehen.

Es Ventajas de los productos

¿Que marca la diferencia en RAK Porcelain?

Innovación en nuestras vajillas, dedicación por y para los profesionales de la hostelería, caracterizada por una inigualable calidad... Que ofrece al unísono arte y altos niveles de calidad para la industria hostelera. Una disposición original y elegante en sus mesas estimula el paladar gracias a una puesta en escena espectacular, se trata de un valor añadido incomparable que da vida a las creaciones culinarias.

¿Cómo conseguimos la excelencia en RAK Porcelain?

Nuestra misión es facilitarles la vida a los profesionales de la hostelería y la restauración. En consecuencia, la ergonomía de sujeción, la facilidad de uso, la resistencia a las variaciones y contrastes térmicos o mecánicos y una robustez óptima son los valores que presiden el proceso de diseño y de producción de todas nuestras colecciones.

Les invitamos a descubrir el resultado de nuestra pasión y de nuestra experiencia en las siguientes páginas.

Garantía

RAK Porcelain y sus redes de distribución ofrecen una garantía limitada para varias colecciones cubriendo desportilladuras (contacte a su distribuidor para más detalles). Sustituimos cualquier artículo que tiene desportilladuras, con la condición de que la denuncia se hace a menos de 5 años a partir de la fecha de compra. Esta garantía sólo es válida para el uso normal de los productos. La garantía no cubre rotura o daño causado por el mal uso o uso no habitual de nuestros productos.

It Vantaggi

Che cosa contraddistingue RAK Porcelain da tutti gli altri?

Le collezioni innovative dedicate ai professionisti e l'impegno che dedichiamo all'offerta di un servizio di qualità.

Quali elementi compongono l'eccellenza?

La creazione, l'ispirazione e, soprattutto, l'instancabile ricerca del migliore equilibrio nella concezione di prodotti studiati per un utilizzo continuo e intensivo. La nostra vocazione è quella di facilitare le attività quotidiane dei professionisti del settore alberghiero e della ristorazione. Tutte le nostre collezioni sono state concepite per garantire una maneggevolezza, una robustezza e una resistenza alle variazioni termiche superiori alla media.

Vi invitiamo quindi a scoprire il risultato del nostro know-how nelle pagine seguenti.

Garanzia

RAK Porcelain e le sue reti di distribuzione offrono una garanzia limitata che copre le scheggiature per la maggior parte delle collezioni (per ottenere maggiori informazioni in merito, siete pregati di contattare il vostro rivenditore). Sostituiamo tutti gli articoli che presentano dei bordi scheggiati, a condizione che il reclamo ci venga inviato entro cinque anni a partire dalla data dell'acquisto. Questa garanzia viene considerata valida solo in caso di utilizzo normale dei prodotti. La garanzia non copre le rotture o i danni risultanti dall'abuso o da un uso non regolare dei nostri prodotti.

QUALITY



En

Microwave

RAK porcelain ensures cooking or quick reheating without altering the taste or flavour of your dishes.

Fr

Micro-ondes

La porcelaine RAK vous assure une cuisson ou un réchauffage rapide sans altération des goûts ou des saveurs de vos préparations.



Holding of temperature

Once put on the table the dishes keep their heat ensuring the content remains at the right temperature giving you the time to enjoy it.

Maintien en température

Une fois sur la table, les plats restent chauds pour maintenir leur contenu à bonne température, le temps de la dégustation.



Dishwasher

The RAK porcelain's smooth enamel is quick and easy to clean. Thanks to the quality, your tableware will stay as new for a long time.

Lave-vaisselle

L'émail lisse de la porcelaine RAK permet un nettoyage facile et rapide. Grâce à leur grande qualité, vos pièces conserveront longtemps leur aspect neuf.



Mechanical shock

The exceptional hardness of the RAK porcelain ensures it is highly chip and shock resistant. It is therefore very easy to stack.

Choc mécanique

La dureté exceptionnelle de la porcelaine RAK lui confère une grande résistance à l'ébréchure et au choc mécanique. L'empilement des différentes pièces est ainsi facilité.



Thermal shock

From the freezer to the microwave, RAK porcelain withstands differences in temperature thanks to the exceptional hardness of its material making it highly thermal shock resistant.

Choc thermique

Du congélateur au micro-ondes, la porcelaine RAK résiste aux écarts de température grâce à la dureté exceptionnelle de son matériau qui lui confère une grande résistance au choc thermique.



100% Hygiene

RAK cooking porcelain is a 100% natural, guaranteed lead-free product. It is non-porous and does not absorb grease, odours or bacteria ensuring you optimum hygiene.

100 % Hygiène

La porcelaine culinaire RAK est un produit 100 % naturel, garantie sans plomb. Non poreuse, elle n'absorbe ni graisses, ni odeurs, ni bactéries et vous assure une hygiène parfaite.

De

Mikrowelle

RAK Porzellan garantiert Ihnen ein Garen oder schnelles Aufwärmen ohne Geschmacks- und Aromaveränderung Ihrer Speisen.

Es

Microondas

La porcelana RAK le garantiza una cocción o un calentamiento rápidos sin alterar el gusto o los sabores de sus platos.

It

Microonde

La porcellana RAK offre una cottura o un riscaldamento rapidi, senza alterare il gusto o il sapore dei piatti.

Warmhalten

Nach dem Servieren bleiben die Teller warm und halten den Inhalt auf einer angemessenen Temperatur, um Speisen ohne Zeitdruck zu genießen.

Mantenimiento de la temperatura

Una vez en la mesa, los platos conservan el calor, para mantener el contenido de estos a la temperatura adecuada durante el tiempo de la degustación.

Mantenimento della temperatura

Una volta a tavola, i piatti restano caldi per mantenere il contenuto alla giusta temperatura durante il periodo di tempo necessario alla degustazione.

Geschirrspüler

Die glatte Oberfläche von RAK Porzellan ermöglicht eine schnelle, einfache Reinigung. Dank ihrer hohen Qualität sehen die Produkte auch nach längerem Gebrauch noch wie neu aus.

Lavavajillas

El esmalte liso de la porcelana RAK permite una limpieza fácil y rápida. Gracias a su gran calidad, las piezas estarán como nuevas durante más tiempo.

Lavastoviglie

Lo smalto liscio della porcellana RAK permette un lavaggio facile e veloce. Grazie all'elevata qualità, i vostri prodotti conserveranno il loro aspetto originario molto a lungo.

Mechanische Stöße

Die außergewöhnliche Härte von RAK Porzellan verstärkt die Kantenfestigkeit und Widerstandskraft gegenüber mechanischen Stößen. Auf diese Weise wird das Stapeln von Teilen erleichtert.

Choque mecánico

Del congelador al microondas, la porcelana RAK resiste las diferencias de temperatura gracias a la excepcional dureza de su material que le confiere una gran resistencia a los choques térmicos.

Shock meccanico

L'eccezionale durata della porcellana RAK garantisce una grande resistenza alla scheggiatura e agli urti meccanici. L'impilamento dei vari pezzi risulta quindi facilitato.

Wärmeschocks

RAK Porzellan widersteht Temperaturunterschieden zwischen Tiefkühlfach und Mikrowelle dank der außergewöhnlichen Härte seines Werkstoffs, die ihm eine hohe Festigkeit gegenüber Temperaturschocks verleiht.

Choque térmico

La porcelana culinaria RAK es un producto 100 % natural, garantizado sin plomo. Al no ser porosa, no absorbe grasas, ni olores, ni bacterias y le garantiza una higiene perfecta.

Shock termico

Dal congelatore al microonde, la porcellana RAK resiste agli sbalzi di temperatura grazie alla durabilità dei suoi materiali, che assicura una grande resistenza alla scheggiatura e agli shock termici.

100% Hygiene

RAK Küchenporzellan ist ein 100% natürliches Produkt, garantiert bleifrei. Es ist unporös und nimmt daher weder Fett noch Gerüche oder Bakterien auf; es sorgt somit für perfekte Hygiene.

100 % Higiene

La porcelana para vajilla RAK es un producto 100% natural, garantizada sin plomo. Al no ser porosa, no absorbe la grasa, ni los olores, ni las bacterias y le garantiza una higiene perfecta.

Igiene impeccabile

La porcellana RAK è un prodotto naturale al 100% e completamente privo di piombo. Non essendo porosa, non assorbe né grassi, né odori, né batteri e assicura un'igiene perfetta.

PRODUCT CARE

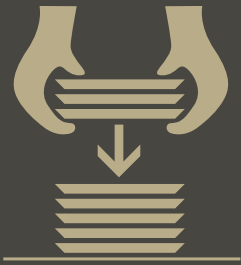

^{En} Stacking

- To preserve the glaze of the flat asymmetrical items, always stack vertically and do not slide one piece onto another.

In the dishwasher

- Follow recommendations of your cleaning product supplier regarding the amount of detergent to use and the use of cleaning products.
- Make sure the dishwashing machine is well-serviced as 80% of the problems are due to low quality maintenance of the dishwashing machine.
- Always rinse the porcelain after use and before you load it into the dishwasher.
- Make sure to wash in separate cycles glass, chinaware, cutlery and cooking equipment (pots and pans).
- If metalmarks appear, clean the surface with Porcelain Cleanser. Check the quality of your cutlery and also wash on a regular basis all working surfaces in stainless steel with a water & vinegar mix. This process will eliminate all metal particles that might be at risk to be transferred on the porcelain.

Chipping

- Chipping is usually the result of rough handling during the washing process or storage.
- Clean the any food remaining on the dinnerware by using a specific utensil; do not hit the dirty plate against the garbage bin.
- RAK hotel grade porcelain is microwave, dishwasher and salmander safe, with most key items being guaranteed against chipping when used under normal conditions.

^{Fr} Empilement

- Pour préserver l'émail protégeant le produit de forme asymétrique, toujours poser verticalement et non pas faire glisser.

Lave-vaisselle

- Suivre les recommandations de votre fournisseur de produits détergents en ce qui concerne le dosage et leur utilisation.
- Assurer la maintenance professionnelle du lave-vaisselle.
- Toujours rincer au préalable les assiettes après utilisation et avant de charger le lave-vaisselle.
- Toujours utiliser des cycles différents pour laver verres, porcelaine, couverts ou équipements de cuisine (casseroles et poêles).
- Si des traces métalliques apparaissent, nettoyer l'article en porcelaine avec du détergent liquide, revoir éventuellement la qualité des couverts, et nettoyer régulièrement les surfaces de travail inoxydables p.ex. à l'eau vinaigrée. Ce processus servira à éliminer les particules métalliques qui risquent de se déposer sur la porcelaine.

Ebréchure

- Les ébréchures sont souvent le résultat de manipulations inadéquates durant le processus de lavage ou de rangement.
- Ne pas taper l'assiette contre le bord de la poubelle, il est recommandé d'utiliser un outil ou l'eau pour dégager le surplus de nourriture.
- La porcelaine professionnelle de RAK passe au four micro-ondes, sauf si elle est décorée de métaux précieux (or/ platine).

De Stapeln

- Um die Glasur des Produkts zu schützen, ist es angebracht, flache asymmetrische Geschirrtteile aufeinander zu stapeln und nicht horizontal ineinander gleiten zu lassen.

Geschirrspülmaschine

- Befolgen Sie die Empfehlungen Ihres Herstellers für Spülmittel, speziell in puncto Dosierung.
- Die Geschirrspülmaschine ist regelmäßig zu warten, 80% der aufgetretenen Probleme sind auf eine unzureichende Wartung der Maschinenteile zurückzuführen.
- Grobe Essensreste müssen mit kaltem Wasser von den Tellern entfernt werden, bevor die Spülmaschine beladen wird.
- Beachten Sie, dass stets getrennte Spülgänge für Gläser, Porzellan, Besteck und Küchengeräte (Töpfe und Pfannen) gewählt werden.
- Wenn dunkle Spuren auf der Glasur auftreten, reinigen Sie den Artikel mit einem weichen Tuch und flüssigem Scheuermittel (Porzellanreiniger). Prüfen Sie ggf. die Qualität Ihrer Bestecke. Reinigen Sie regelmäßig mit einer Wasser-Essig Lösung alle Arbeitsflächen aus Edelstahl in Ihrer Küche. Dieser Vorgang eliminiert Metallpartikel die sich am Porzellan absetzen können.

Kantenabsplitterung

- Kantenabsplitterungen sind zumeist das Ergebnis eines nicht-fachgerechten Umgangs während des Spülvorgangs oder beim Einräumen/Transport des Geschirrs.
- Schlagen Sie den Teller nicht gegen den Rand des Mülleimers, benutzen Sie eine Gabel oder eine Dusche um die Reste vom Teller zu spülen.
- Unser Porzellan ist, dank einer verstärkten Scherbenhärte, für den Mikrowellenherd, den Geschirrspüler und den Salamander geeignet. Wichtige Porzellanteile die bei normaler Nutzung eine Kantenabsplitterung aufweisen, werden ersetzt.

Es Apilamiento

- Para preservar el esmalte vidriado de los productos asimétricos, apilar siempre verticalmente y no deslizar en horizontal.

Lavavajillas

- Seguir las recomendaciones de uso de su proveedor de productos detergentes en lo relativo a su dosificación y manejo.
- Realizar siempre el debido mantenimiento del lavavajillas, ya que el 80 % de los problemas surgidos provienen de un mantenimiento incorrecto.
- Enjuagar siempre los platos después de su uso y antes de introducirlos en el lavavajillas.
- Utilizar siempre ciclos diferentes para lavar vidrio, porcelana, cubiertos o baterías de cocina.
- Si aparecen huellas metálicas, limpiar el artículo de porcelana con jabón líquido sanitario.
- Si aparecen marcas de metal en su porcelana primero limpie la superficie con un limpiador de porcelanas. Compruebe la calidad de sus cubiertos y lave a menudo las superficies trabajo, especialmente aquellas donde se usen éstos, con una mezcla de agua y vinagre. Este proceso eliminará todas las partículas de metal que pudieran ser transferidas a las piezas de porcelana. Las marcas de metal también pueden deberse al apilamiento, cuando hay bajo un plato polvo metálico de acero inoxidable y éste se deposita sobre la parte superior de la siguiente pieza de vajilla.

Desportilladuras

- El desportillado es a menudo el resultado de una manipulación muy brusca durante el proceso de lavado o colocación.
- No sacudir el plato contra el borde del cubo de la basura, utilizar mejor un tenedor, o un utensilio de cocina específico para tirar las sobras.
- Nuestra porcelana profesional es compatible con el microondas y el lavavajillas, y presenta una gran resistencia a las desportilladuras, siempre teniendo en cuenta que se den las en condiciones normales y adecuadas de uso.

It Impilamento

- Per preservare lo smalto che protegge i prodotti dalla forma asimmetrica, posateli sempre verticalmente ed evitate che scivolino.

Lavastoviglie

- Seguite le raccomandazioni del vostro fornitore di detergenti per quanto concerne il dosaggio e l'impiego di questi ultimi.
- Assicurate una manutenzione professionale della lavastoviglie.
- Risciacquate sempre i piatti dopo l'utilizzo e prima di caricare la lavastoviglie.
- Utilizzate cicli diversi per lavare vetro, porcellana, posate e altri utensili da cucina (pentole e padelle).
- In presenza di tracce metalliche, lavate porcellana con un detergente liquido, esaminate eventualmente la qualità delle posate e pulite regolarmente le superfici di lavoro inossidabili ad es. con acqua e aceto. Questa procedura serve a eliminare le particelle metalliche che possono depositarsi sulla porcellana.

Scheggiatura

- Le scheggiature sono spesso il risultato di manipolazioni non adeguate durante i processi di lavaggio o di sistemazione.
- Evitate di sbattere il piatto contro il bordo della pattumiera: per gettare gli avanzi di cibo, è consigliabile aiutarsi con uno strumento o con dell'acqua.
- La porcellana professionale RAK può essere messa nel forno a microonde, salvo nel caso in cui sia decorata con metalli preziosi (oro/platino).

SEGMENTATION

INSPIRATIONAL DINING

En

With our serving ware leading chefs can let their imagination run wild with the INSPIRATIONAL DINING series, offering a number of different designs and a myriad of possibilities.

Fr

Pour que les grands chefs puissent laisser libre cours à leur imagination, les séries INSPIRATIONAL DINING offrent des designs variés et une myriade de possibilités.

ELEGANT DINING

En

Complete, timeless, ultra-chic or classic, the ELEGANT DINING series are the heart and soul of these fine porcelain dinner services, designed specifically for the hotel industry.

Fr

Complètes, intemporelles, ultra-chics ou classiques, les séries ELEGANT DINING forment l'âme même des services de porcelaine raffinés consacrés à l'hôtellerie.

CASUAL DINING

En

The CASUAL DINING range is the perfect answer when a balance between functionality, durability and elegance is key.

Fr

Partout où l'équilibre entre fonctionnalité, robustesse et élégance est indispensable, les articles de la gamme CASUAL DINING ont leur place.

ALL PURPOSE DINING

En

RAK Porcelain sets strict standards for its products to ensure they stand up to daily professional use. The ALL PURPOSE DINING series are designed specifically for commercial and mass catering.

Fr

RAK Porcelaine impose à ses produits des critères sévères afin de convenir à l'usage des professionnels au quotidien. Les séries ALL PURPOSE DINING sont dédiées à l'exploitation en restauration commerciale et collective.

ADDITIONS

En

The RAK Porcelain range would be incomplete without these essential additional products. The ADDITIONS range, including accessories and items with specific uses and for specific services, is a treasure trove marrying inventiveness with functionality.

Fr

La gamme RAK Porcelaine serait incomplète sans les indispensables produits complémentaires. Entre accessoires, articles aux fonctions spécifiques et de service, ADDITIONS recèle des trésors d'inventivité et de fonctionnalité.

De

Damit die großen Meisterköche ihrer Kreativität freien Lauf lassen können, bieten die Serien INSPIRATIONAL DINING unterschiedliche Designs und eine Vielzahl von Möglichkeiten.

Es

Para que los mejores chefs puedan dar rienda suelta a su imaginación, las series INSPIRATIONAL DINING ofrecen diseños variados y una miríada de posibilidades.

It

Perché i grandi chef possano dare libero sfogo alla loro immaginazione, le serie INSPIRATIONAL DINING offrono design vari e una miriade di possibilità.

De

Die umfassenden, zeitlosen, hochmodernen oder klassischen Serien ELEGANT DINING bilden die Seele der raffinierten Porzellan-Service für den Hotelbereich.

Es

Completas, atemporales, sumamente elegantes o clásicas, las series ELEGANT DINING constituyen el alma misma de los servicios de porcelana refinados consagrados a la hostelería.

It

Complete, senza tempo, ultra-chic o classiche, le serie ELEGANT DINING rappresentano l'anima stessa dei raffinati servizi di porcellana ideati per il settore dell'ospitalità.

De

Überall dort, wo Funktionalität, Robustheit und Eleganz gleichermaßen gefragt sind, kommt das Sortiment CASUAL DINING zum Einsatz.

Es

Donde el equilibrio entre la funcionalidad, la robustez y la elegancia es indispensable, no pueden faltar los artículos de la gama CASUAL DINING.

It

Ovunque, dove l'equilibrio tra funzionalità, robustezza ed eleganza è indispensabile, gli articoli della gamma CASUAL DINING trovano il loro posto.

De

RAK Porzellan legt strenge Maßstäbe bei seinen Produkten an, damit sie für den täglichen Gebrauch im professionellen Bereich geeignet sind. Die Serien ALL PURPOSE DINING sind für den Einsatz in der Großgastronomie bestimmt.

Es

RAK Porcelain impone a sus productos criterios rigurosos para que sirvan para el uso profesional cotidiano. Las series ALL PURPOSE DINING están dedicadas a la explotación en restauración comercial y colectiva.

It

RAK Porcelain impone ai suoi prodotti criteri severi affinché siano adatti ad essere impiegati ogni giorno dai professionisti. Le serie ALL PURPOSE DINING sono dedicate alla ristorazione commerciale e collettiva.

De

Das RAK Porzellan Sortiment wäre ohne die unentbehrlichen ergänzenden Produkte unvollständig. Neben Zubehör, Artikeln mit spezifischer Funktion und für den Service birgt ADDITIONS wahre Schätze an Einfallreichtum und Funktionalität.

Es

La gama RAK Porcelain estaría incompleta sin los indispensables productos complementarios. Entre accesorios, artículos de función específica y de servicio, ADDITIONS encierra tesoros de la imaginación y la funcionalidad.

It

La gamma RAK Porcelain sarebbe incompleta senza gli indispensabili prodotti complementari. Tra accessori, articoli dalle funzioni specifiche e di servizio, ADDITIONS racchiude tesori di inventività e funzionalità.

SEGMENTATION

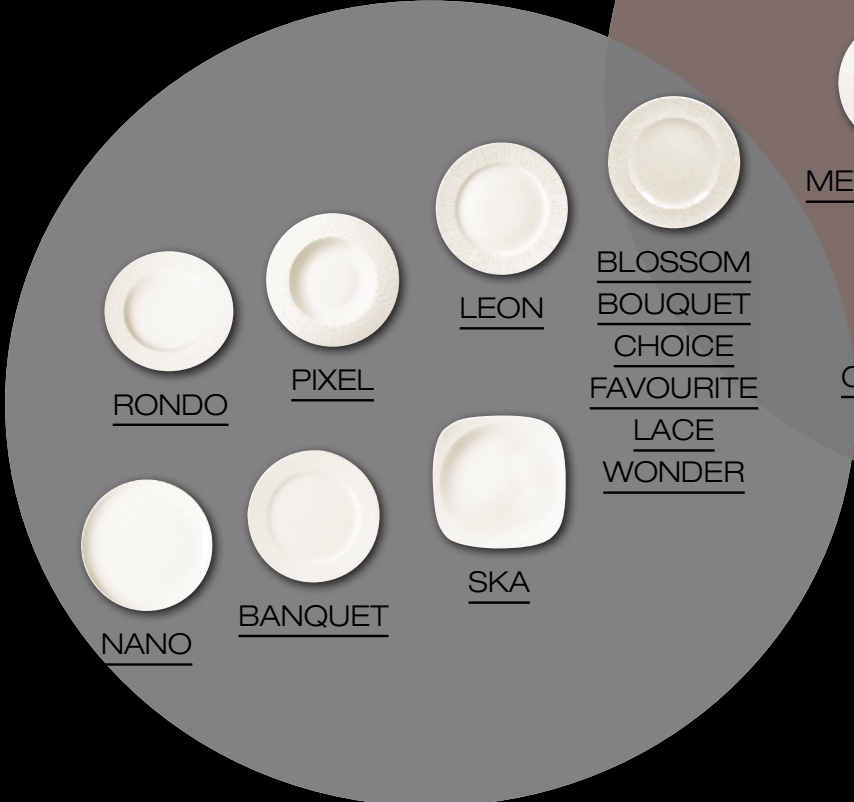

RONDO

PIXEL

LEON

BLOSSOM
BOUQUET
CHOICE
FAVOURITE
LACE
WONDER

NANO

BANQUET

SKA

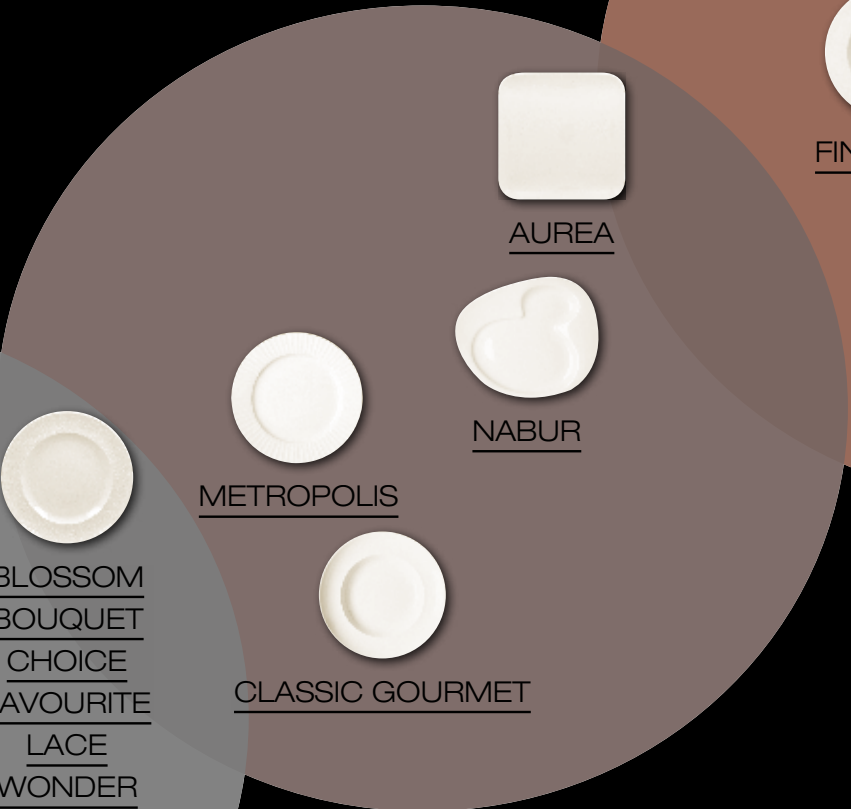

AUREA

NABUR

METROPOLIS

CLASSIC GOURMET



FINE

INSPIRATIONAL
DINING

ELEGANT
DINING

CASUAL
DINING

ALL PURPOSE
DINING

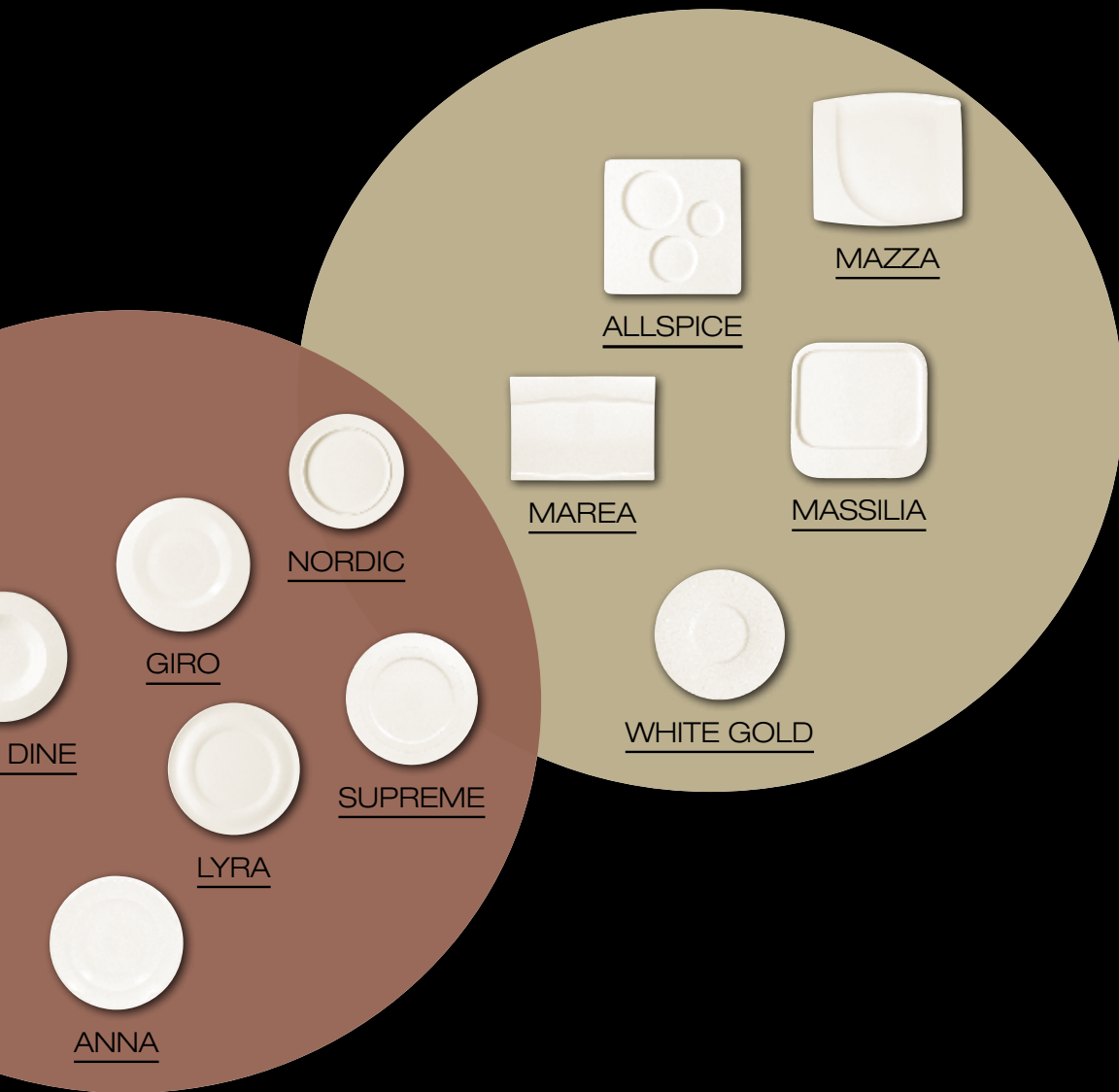

ALLSPICE



MAZZA



MAREA



MASSILIA



WHITE GOLD



NORDIC



GIRO



DINE



SUPREME

LYRA



ANNA

SHAPES

Round with rim / Rund mit Rand / Ronde à aile / Redondo con ala

Banquet 



Pixel 



Classic Gourmet 



Metropolis 



Fine Dine 



Lyra 



Nordic 



White Gold 



Anna 



Giro 



Marea Circus 



Square / Quadratisch / Carrée / Cuadrado

White Gold 



Classic Gourmet 



Mazza 



Ska 



Aurea 



Allspice
Ginger 



Allspice
Sesame 



Allspice
Peppermint 



Massilia 



Nano 



Marea Astro 



Heavy-duty
Für intensiven Gebrauch
Usage intensif
Usu intensivo



Intensive use
Für häufigen Gebrauch
Usage soutenu
Usu costante

Asymmetric Design / Asymmetrisch / Asymétrique / Asimétrico



Round rimless / Rund ohne Rand / Ronde coupe / Redondo sin borde



Oval / Oval / Ovale / Oval

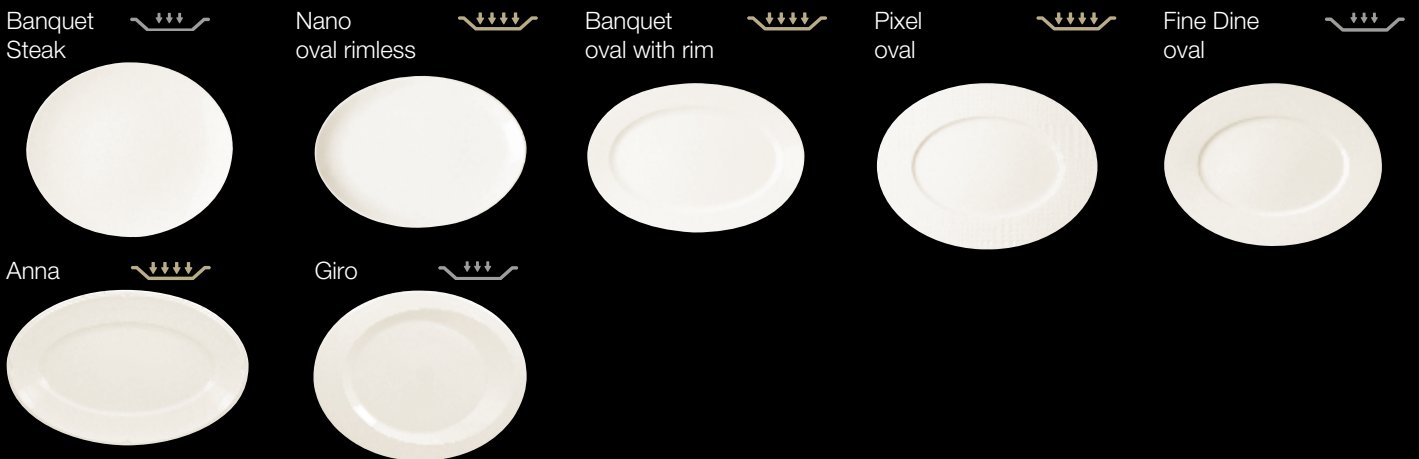

Rectangular / Rechteckig / Rectangulaire / Rectangular

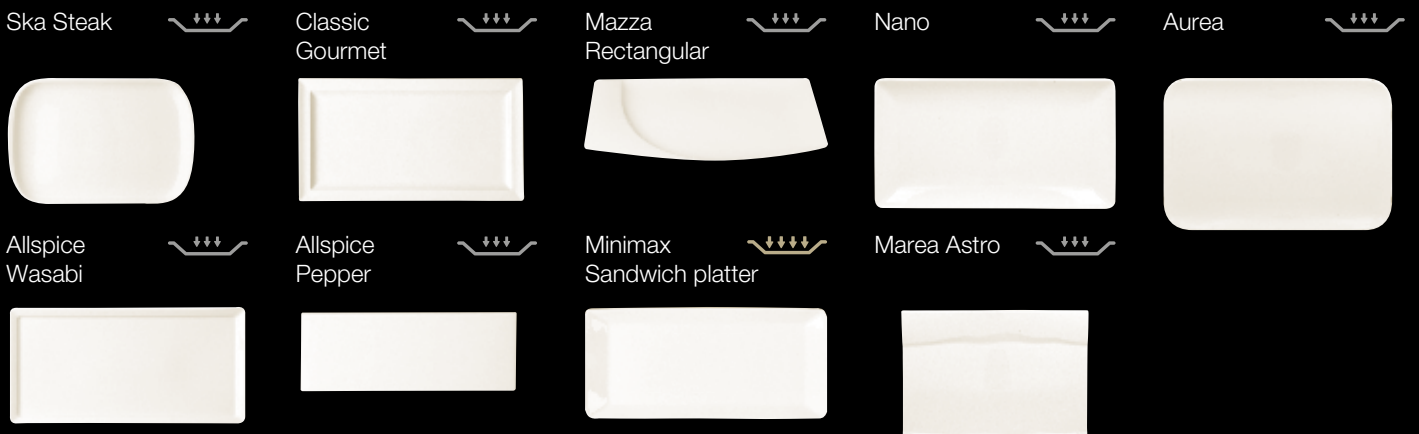









PLATES SPECIFICATIONS

Reference Référence Referenz Referencia Riferimento	Item Article Artikel Artículo Articolo	Profile view Vue de profil Profilschnitt Vista de perfil Vista laterale	Thickness of the rim Épaisseur de l'aile Randstärke Espesor de la ala Spessore del bordo	Profile type Type de profil Profiltyp Tipo de perfil Tipo di profilo	Lateral shock resistance Résistance aux chocs latéraux Bruchwiderstand Resistencia de choque lateral Resistenza agli urti laterali
MRDP27	Marea Switch 27 cm - 10.65"		4.0 mm 0.16"	Sharp Saillant Scharf Saliente Sporgente	★★
AUSP27	Aurea 27 cm - 10.65"		4.5 mm 0.18"	Sharp Saillant Scharf Saliente Sporgente	★★★
GIFP27	Giro round plate 27 cm - 10.65"		3.9 mm 0.15"	Sharp Saillant Scharf Saliente Sporgente	★★
FDFP27	Fine Dine 27 cm - 10.65"		3.6 mm 0.14"	Sharp Saillant Scharf Saliente Sporgente	★★
NOFP28	Nordic 28 cm - 11"		3.0 mm 0.12"	Sharp Saillant Scharf Saliente Sporgente	★★
GDSP26	White Gold King* 26 cm - 10.25"		5.0 mm 0.20"	Rolled Rond Rund Redondo Rotondo	★★★
LRFP27	Lyra 27 cm - 10.65"		4.8 mm 0.19"	Sharp Saillant Scharf Saliente Sporgente	★★
NBFP27	Nabur 27 cm - 10.65"		4.0 mm 0.16"	Rolled Rond Rund Redondo Rotondo	★★
ANFP27	Anna 27 cm - 10.65"		5.0 mm 0.20"	Strength Rond renforcé Rund verstärkt Redondeado reforzado Rotondo rinforzato	★★★★
MSFP27	Massilia 27 cm - 10.65"		4.0 mm 0.16"	Sharp Saillant Scharf Saliente Sporgente	★★★

Weight Poids Gewicht Peso Peso	Recommendations of use Recommandations d'usage Gebrauchsempfehlungen Recomendación de uso Consigli per l'uso		Design perception Perception design Design-Empfindung Percepción diseño Percezione del design
640 g 1.40 lb	Intensive Soutenu Sehr häufig Constante Costante	Fine dining Restauration haut de gamme Top-Gastronomie Restauración de gama alta Ristorazione di alta gamma	Premium Premium Premium Premium ★★★★★
1080 g 2.20 lb	Intensive Soutenu Sehr häufig Constante Costante	Fine dining Restauration haut de gamme Top-Gastronomie Restauración de gama alta Ristorazione di alta gamma	Premium Premium Premium Premium ★★★★★
622 g 1.40 lb	Intensive Soutenu Sehr häufig Constante Costante	Fine dining Restauration haut de gamme Top-Gastronomie Restauración de gama alta Ristorazione di alta gamma	Premium Premium Premium Premium ★★★★★
640 g 1.40 lb	Intensive Soutenu Sehr häufig Constante Costante	Fine dining Restauration haut de gamme Top-Gastronomie Restauración de gama alta Ristorazione di alta gamma	Premium Premium Premium Premium ★★★★★
810 g 1.80 lb	Intensive Soutenu Sehr häufig Constante Costante	Fine dining Restauration haut de gamme Top-Gastronomie Restauración de gama alta Ristorazione di alta gamma	Premium Premium Premium Premium ★★★★★
970 g 2.13 lb	Intensive Soutenu Sehr häufig Constante Costante	Fine dining Restauration haut de gamme Top-Gastronomie Restauración de gama alta Ristorazione di alta gamma	Premium Premium Premium Premium ★★★★★
710 g 1.55 lb	Intensive Soutenu Sehr häufig Constante Costante	Fine dining Restauration haut de gamme Top-Gastronomie Restauración de gama alta Ristorazione di alta gamma	Premium Premium Premium Premium ★★★★★
676 g 1.25 lb	Intensive Soutenu Sehr häufig Constante Costante	Fine dining Restauration haut de gamme Top-Gastronomie Restauración de gama alta Ristorazione di alta gamma	Premium Premium Premium Premium ★★★★★
810 g 1.77 lb	Heavy-duty Intensif Intensiv Intensivo Intensivo	Bistro-Brasserie - banqueting - catering Bistro-Brasserie - banqueting - catering Großgaststätten - banqueting - catering Bar - cervecería - banquets - catering Bistro, brasserie, banchetti, catering	Elegant Élégant Elegant Elegante ★★★★★
730 g 1.62 lb	Intensive Soutenu Sehr häufig Constante Costante	Fine dining Restauration haut de gamme Top-Gastronomie Restauración de gama alta Ristorazione di alta gamma	Premium Premium Premium Premium ★★★★★

PLATES SPECIFICATIONS

Reference Référence Referenz Referencia Riferimento	Item Article Artikel Artículo Articolo	Profile view Vue de profil Profilschnitt Vista de perfil Vista laterale	Thickness of the rim Épaisseur de l'aile Randstärke Espesor de la ala Spessore del bordo	Profile type Type de profil Profiltyp Tipo de perfil Tipo di profilo	Lateral shock resistance Résistance aux chocs latéraux Bruchwiderstand Resistencia de choque lateral Resistenza agli urti laterali
SPSP27	Allspice 27 cm - 10.65"		4.0 mm 0.16"	Sharp Saillant Scharf Saliente Sporgente	★★
MZSP26	Mazza 26 cm - 10.25"		4.5 mm 0.18"	Sharp Saillant Scharf Saliente Sporgente	★★
CLFP27	Classic Gourmet 27 cm - 10.65"		5.0 mm 0.20"	Strength Rond renforcé Rund verstärkt Redondeado reforzado Rotondo rinforzato	★★★★
SKRFP28	Ska Round 28 cm - 11"		4.5 mm 0.18"	Rolled Rond Rund Redondo Rotondo	★★★★
PXFP27	Pixel 27 cm - 10.65"		5.0 mm 0.20"	Strength Rond renforcé Rund verstärkt Redondeado reforzado Rotondo rinforzato	★★★★★
SKSFP27	Ska Square 27 cm - 10.65"		5.1 mm 0.20"	Rolled Rond Rund Redondo Rotondo	★★★★★
BAFP27	Banquet* 27 cm - 10.65"		5.1 mm 0.20"	Strength Rond renforcé Rund verstärkt Redondeado reforzado Rotondo rinforzato	★★★★★
NNPR27	Nano 27 cm - 10.65"		4 mm 0.16"	Rolled Rond Rund Redondo Rotondo	★★

* Also applies on Metropolis, Leon, Rondo / Applicable également sur Metropolis, Leon, Rondo / Auch auf Metropolis, Leon, Rondo / Aplicable también sobre Metropolis, Leon, Rondo / Applicabile anche alle collezioni Metropolis, Leon e Rondo

Weight Poids Gewicht Peso Peso	Recommendations of use Recommandations d'usage Gebrauchsempfehlungen Recomendación de uso Consigli per l'uso		Design perception Perception design Design-Empfindung Percepción diseño Percezione del design
900 g 2 lb	Intensive Soutenu Sehr häufig Constante Costante	Fast moving restaurants Restauration traditionnelle Großgastronomie Restauración tradicional Ristorazione tradizionale	Elegant Éléant Elegant Elegante Elegante
640 g 1.40 lb	Semi-intensive Semi-intensif Häufig Semi-intensivo Semi-intensivo	Fast moving restaurants Restauration traditionnelle Großgastronomie Restauración tradicional Ristorazione tradizionale	Elegant Éléant Elegant Elegante Elegante
700 g 1.50 lb	Heavy-duty Intensif Intensiv Intensivo Intensivo	Bistro-Brasserie - banqueting - catering Bistro-Brasserie - banqueting - catering Großgaststätten - banqueting - catering Bar - cervecería - banquets - catering Bistro, brasserie, banchetti, catering	Elegant Éléant Elegant Elegante Elegante
930 g 2 lb	Heavy-duty Intensif Intensiv Intensivo Intensivo	Bistro-Brasserie - banqueting - catering Bistro-Brasserie - banqueting - catering Großgaststätten - banqueting - catering Bar - cervecería - banquets - catering Bistro, brasserie, banchetti, catering	Standard Courant Standard Estándar Ordinario
730 g 1.62 lb	Heavy-duty Intensif Intensiv Intensivo Intensivo	Bistro-Brasserie - banqueting - catering Bistro-Brasserie - banqueting - catering Großgaststätten - banqueting - catering Bar - cervecería - banquets - catering Bistro, brasserie, banchetti, catering	Standard Courant Standard Estándar Ordinario
915 g 2 lb	Heavy-duty Intensif Intensiv Intensivo Intensivo	Bistro-Brasserie - banqueting - catering Bistro-Brasserie - banqueting - catering Großgaststätten - banqueting - catering Bar - cervecería - banquets - catering Bistro, brasserie, banchetti, catering	Strong, standard Robuste, courant Robust, standard Robusto, estándar Robusto, ordinario
755 g 1.66 lb	Heavy-duty Intensif Intensiv Intensivo Intensivo	Bistro-brasserie - banqueting - catering Bistro-brasserie - banqueting - catering Großgaststätten - banqueting - catering Bar - cervecería - banquets - catering Bistro, brasserie, banchetti, catering	Strong, standard Robuste, courant Robust, standard Robusto, estándar Robusto, ordinario
730 g 1.62 lb	Semi-intensive Semi-intensif Häufig Semi-intensivo Semi-intensivo	Bistro-brasserie - banqueting - catering Bistro-brasserie - banqueting - catering Großgaststätten - banqueting - catering Bar - cervecería - banquets - catering Bistro, brasserie, banchetti, catering	Standard Courant Standard Estándar Ordinario

Gemma Bernal



En

Gemma Bernal has spent her professional life in design, thinking of products in a different light. In her opinion, a designer is a person who captures different aspects of life: functional, economic, social, marketing, production etc. through its own sensitivity. Ideas and design proposals arise out of this multidisciplinary conception and a close relationship with the right people. She shares her work life between design creation and design teaching that forced her to define, explain and communicate her own vision. Gemma's work has been tremendously influenced by Mediterranean atmosphere and particularly Barcelona in terms of sun, light and joyful people sharing meals together on restaurants' terraces. Gemma has worked with various renowned chefs sharing a Mediterranean vision. In the past years, she has found inspiration in young chefs and professional reviewers seeking different approaches in culinary activities. Gemma designed two beautiful collections called MAREA and GIRO developed by RAK Porcelain. MAREA features different pieces for tapas dishes, main

Fr

Gemma Bernal a consacré sa vie professionnelle au design, envisageant les produits sous un angle différent. Selon elle, un designer est une personne qui saisit différents aspects de la vie – fonctionnels, économiques, sociaux, marketing, de production, etc. – en fonction de sa propre sensibilité. Les idées et les propositions de design naissent de cette conception pluridisciplinaire et d'une relation étroite avec les bonnes personnes. Elle partage sa vie professionnelle entre la création de design et l'enseignement du design qui l'a amené à définir, expliquer et communiquer sa propre vision. Le travail de Gemma a été considérablement influencé par l'atmosphère méditerranéenne, notamment Barcelone, en termes de soleil, de lumière et de personnes prenant gaiement leurs repas ensemble sur les terrasses des restaurants. Gemma a travaillé avec divers chefs de renom partageant sa vision de la Méditerranée. Ces dernières années, elle a trouvé l'inspiration auprès de jeunes chefs et de critiques professionnels recherchant différentes approches en termes d'activités culinaires. Gemma a conçu deux superbes

Gemma's work has been atmosphere and particularly people sharing meals together



and side dishes to bring up culinary presentations. These pieces have been conceptualized for a specific use and design oriented to ease service and product manipulation. GIRO is based on geometric forms in which identical shapes in different sizes have been somewhat arbitrarily inserted. The result is an appearance of different sized tilted planes and inclinations showcasing the design's dexterity and originality. Gemma feels very comfortable working in close cooperation with other designers in a lab for ideas developing new concepts related to food and cooking.

collections baptisées MAREA et GIRO développées par RAK Porcelaine. MAREA comprend différentes pièces pour des plats de type tapas, des plats principaux et des plats d'accompagnement pour mettre en valeur des présentations culinaires. Ces pièces ont été conceptualisées pour une utilisation spécifique et un design destiné à faciliter le service et la manipulation du produit. GIRO repose sur des formes géométriques dans lesquelles des formes identiques dans des tailles différentes ont été insérées de manière arbitraire. Le résultat est une apparence de plans inclinés et d'inclinaisons de tailles différentes illustrant la dextérité et l'originalité du design. Gemma se sent dans son élément lorsqu'elle travaille en étroite collaboration avec d'autres designers dans un laboratoire dans le but de faire naître des idées développant de nouveaux concepts liés à la nourriture et à la cuisine.

De

Gemma Bernal hat ihr berufliches Leben mit Design verbracht und damit, Produkte in einem anderen Licht zu betrachten. Ihrer Meinung nach handelt es sich bei einem Designer um einen Menschen, der die verschiedenen Aspekte des Lebens durch sein eigenes Empfinden erfasst: Funktionalität, Wirtschaftlichkeit und Gesellschaft, Marketing, Herstellung usw. Ideen und Designvorschläge entstehen aus diesem multidisziplinären Konzept und einer engen Beziehung zu den richtigen Menschen. Sie teilt ihr Arbeitsleben zwischen der Designerstellung und der Designlehre auf, sodass sie gezwungen war, ihre eigene Vision zu definieren, zu erklären und zu vermitteln. Gemmas Werk wurde stark von einer mediterranen Atmosphäre - und insbesondere von Barcelona - beeinflusst, was Sonne, Licht und fröhliche Menschen betrifft, die auf der Terrasse eines Restaurants gemeinsam eine Mahlzeit zu sich nehmen. Gemma hat mit verschiedenen bekannten Köchen zusammengearbeitet, die ihre mediterrane Vision teilen. In den letzten Jahren ließ sie sich von jungen Köchen und professionellen Kritikern inspirieren die nach neuen Ansätzen für ihre

Es

Gemma Bernal ha pasado toda su vida diseñando. Pensando en productos de diversa índole. Piensa en el diseñador como una persona que capta distintos aspectos: Funcionales, económicos, sociales, marketing, producción, actualidad etc. De ésta visión pluridisciplinar y del contacto con las personas adecuadas, surgen las ideas y propuestas. Comparte su vida laboral con la enseñanza del diseño y nos cuenta como ha aprendido enseñando ya que le ha obligado a saber definir y explicar las cosas. La influencia mediterránea, el sol, la luz, la gente en la calle, el ambiente de Barcelona... son cosas que influyen en Gemma enormemente. Estamos en un lugar en que se vive mucho en la calle, se disfruta mucho celebrando cosas en grupo y casi siempre en restaurantes. Gemma ha trabajado con diversos e importantes chefs, también con una visión muy mediterránea. En los últimos años ha buscado fuentes de inspiración en chefs jóvenes, personas críticas que se plantean aspectos de interés relacionados con el acto de comer, y las distintas formas de hacerlo.

It

Gemma Bernal ha trascorso tutta la sua vita professionale nel design, pensando ai prodotti sotto una luce diversa. Secondo lei, un designer, grazie alla sua sensibilità, riesce a catturare differenti aspetti della vita: funzionale, economico, sociale, marketing, produzione e tanti altri. Le idee e le proposte di design prendono vita da questa concezione multidisciplinare e da una stretta relazione con le persone giuste. Gemma, condivide la sua vita lavorativa tra creazione e insegnamento del design, e ciò la porta a definire, spiegare e comunicare la sua visione. Il lavoro di Gemma è stato straordinariamente influenzato dall'atmosfera mediterranea e, in particolare, da Barcellona in termini di sole, luce e persone gioiose, pranzando insieme a loro nei dehors dei ristoranti. Gemma, ha lavorato con vari chef di fama, con cui condivide una visione mediterranea. In passato, ha trovato ispirazione nei giovani chef e, nei critici professionisti che cercano approcci differenti nelle attività culinarie. Gemma, ha disegnato due fantastiche collezioni chiamate MAREA e GIRO sviluppate da RAK Porcelain. MAREA

tremendously influenced by Mediterranean Barcelona in terms of sun, light and joyful on restaurants' terraces.

kulinarischen Aktivitäten suchten. Gemma hat zwei wunderschöne Kollektionen entworfen, MAREA und GIRO, die von RAK Porzellan entwickelt wurden. MAREA zeigt verschiedene Stücke zur kulinarischen Präsentation von Tapas-Gerichten, Hauptspeisen und Beilagen. Diese Stücke wurden für den besonderen Gebrauch konzipiert, und ihr Design soll die Bedienung bei Tisch sowie die Handhabung des Produktes vereinfachen. GIRO basiert auf geometrischen Formen, in die wiederum die gleiche Geometrie in verschiedenen Größen ein wenig willkürlich eingefügt wurde. Das Ergebnis ist ein Erscheinungsbild schräger Ebenen von unterschiedlicher Größe und Neigung, die die Gewandtheit und die Originalität dieses Designs deutlich werden lassen. Gemma arbeitet sehr gerne eng mit anderen Designern in einem Ideenlabor zusammen und entwickelt neue Konzepte im Bereich Essen und Kochen.

RAK ha desarrollado los proyectos MAREA y GIRO. MAREA propone distintas piezas con funciones muy concretas. Productos para tapas, para complementos de una presentación culinaria o como un gran plato. Piezas que tienen una utilidad concreta y una resolución clara para el servicio y la manipulación del producto. GIRO se basa en formas geométricas básicas en las que se insertan unas formas iguales, de distintas dimensiones, de una manera un poco arbitraria. El resultado es la aparición de planos inclinados de distintas dimensiones e inclinaciones que le dan al producto un gran interés formal. Gemma se siente muy cómoda desarrollando, junto con otros diseñadores que trabajan en el laboratorio de ideas, nuevos conceptos relacionados con la gastronomía y la cocina.

è costituita da pezzi differenti per tapas, piatti principali e contorni che mettono in luce le presentazioni culinarie. Questi pezzi sono stati concettualizzati per un uso specifico e orientati al design, per facilitare il servizio e la manipolazione dei prodotti. GIRO si basa su forme geometriche, dove sono state inserite arbitrariamente sagome identiche di misure differenti. Ne risulta un'immagine di inclinazioni e piani pendenti di varie misure che evidenziano l'abilità e l'originalità del design. Gemma si sente a proprio agio a lavorare in stretta collaborazione con altri designer in un laboratorio di idee sviluppando nuovi concetti legati al cibo e alla cucina.

Françoise Boeur



En

From hunting weapons to tableware, Françoise Boeur has an extensive track record in graphic design, characterised by creativity, love of detail and above all this, a great passion. Françoise Boeur was born in 1964 in Bastogne, Belgium. From an early age, craftsmanship and nature were strong influences in her life. When she was 20, she qualified as an art teacher from the Avroy Institute in Liège, Belgium, and started teaching. In 1986 she moved into an unusual and globally sought-after specialism by becoming a hunting weapon engraver at the Léon-Mignon Institute in Liège. She has done an extensive range of artistic work: poster contests, animal drawings, pencil sketch exhibitions and more. Françoise has always been guided in her work by a leitmotiv: producing unique and realistic artwork, exhibiting a great attention to detail. In 1988 she shifted into the world of tableware, for

Fr

Des armes de chasse aux arts de la table, Françoise Boeur possède un long parcours de designer graphique marqué par la créativité, l'amour du détail et surtout la passion. Françoise Boeur naît en 1964 à Bastogne en Belgique. Son enfance est fortement imprégnée par le travail artisanal et la nature. A 20 ans déjà, elle obtient le diplôme de professeur d'arts plastiques de l'institut Avroy de Liège (Belgique) et commence à enseigner. Elle poursuit en 1986 avec une spécialisation rare et mondialement recherchée : elle devient graveur ciseleur sur arme de chasse à l'institut Léon-Mignon de Liège. Ses activités artistiques s'étendent : concours d'affiches, dessins animaliers, expositions de dessins au crayon etc. Un leitmotiv guide Françoise pour ses travaux : composer des oeuvres réalistes et atypiques basées sur le souci du détail. En 1988 elle se tourne vers l'univers des arts de la table précisément dans le secteur

In 1986, Françoise moved specialism by becoming a at the Belgian Léon-Mignon

hotels and restaurants in particular. She is active in creating and fully developing custom designs on porcelain for prestigious clients all around the world. Her portfolio includes the London Hilton Hotel, Relais & Châteaux, Radisson Kuwait, Disneyland Paris, the Colloseo Hotel at Europa Park, Casino Barrière, the Grand-Ducal Palace of Luxembourg, star-rated restaurants such as Léa Linster, and a catalogue of designs that have enjoyed fully-deserved success with her clients. She joined the young team at RAK Porcelain Europe in 2010, and since then she has produced many outstanding designs for a wide variety of establishments in Europe. This allows her to put her talents to use to make remarkable and acclaimed works.

de l'hôtellerie restauration. Elle participe à l'étude et à la réalisation intégrale de décors personnalisés sur la porcelaine pour des clients prestigieux dans le monde entier. A son actif : Hôtel Hilton London, les Relais & Châteaux, Radisson Koweït, Disneyland Paris, Colloseo à Europa Park, Casino Barrière, le Palais Grand-Ducal de Luxembourg, des restaurants étoilés comme Léa Linster ainsi que des décors en catalogue ayant rencontré auprès de ses clients un succès entièrement mérité. Elle rejoint la toute jeune équipe de RAK Porcelain Europe en 2010 avec laquelle elle développe de nombreux et exceptionnels décors pour des établissements européens très divers. Elle a ainsi l'occasion de mettre son talent à profit pour des créations remarquables et remarquées.



De

Von Jagdwaffen bis zu Tafelgeschirr verzeichnet Françoise Boeur eine umfassende Erfolgsgeschichte im Bereich Grafikdesign, die von Kreativität, Liebe zum Detail und vor allem einer großen Leidenschaft geprägt ist. Françoise Boeur wurde 1964 in Bastogne, Belgien, geboren. Schon in jungen Jahren haben Handwerkskunst und Natur ihr Leben stark beeinflusst. Als sie 20 Jahre alt war, machte sie ihren Abschluss als Kunstlehrerin am Avroy-Institut in Lüttich, Belgien, und begann mit ihrer Lehrtätigkeit. 1986 spezialisierte sie sich auf einem ungewöhnlichen und weltweit gefragten Gebiet, indem sie am Léon-Mignon-Institut in Lüttich zur Graveurin für Jagdwaffen wurde. Sie hat viele Gebiete der Kunst abgedeckt: Plakatwettbewerbe, Tierzeichnungen, Ausstellungen von Bleistiftskizzen u.v.m. Françoise folgte bei ihren Arbeiten immer einem Leitmotiv: einzigartige und realistische Kunstwerke zu schaffen, die

Es

Françoise Boeur posee una amplia trayectoria en diseño gráfico, desde armas de caza a vajillas, caracterizada por su creatividad, su pasión por el detalle y, sobre todo, su gran amor por lo que hace. Françoise Boeur nació en 1964 en Bastogne, Bélgica. Desde muy temprana edad, la naturaleza y la artesanía ejercieron una gran influencia en su vida. A la edad de 20 años obtuvo una plaza como profesora de arte en el Instituto Avroy de Lieja, en Bélgica, donde se dedicó a la enseñanza. En 1986 inició su especialidad en el Instituto Léon-Mignon de Lieja en un área poco frecuente y muy solicitado en todo el mundo, al convertirse en grabadora de armas de caza. Su trabajo artístico, que es amplio y muy variado, abarca concursos de carteles, dibujos de animales, exposiciones de bocetos a lápiz y mucho más. La obra de Françoise está siempre guiada por el leitmotiv de producir un trabajo artístico realista y

It

Dai fucili per la caccia ai servizi per la tavola, Françoise Boeur ha una profonda esperienza nel graphic design, caratterizzata da creatività, amore per il dettaglio e, soprattutto, una grande passione. Françoise Boeur è nata nel 1964 a Bastogne, in Belgio. Fin dall'inizio, la maestria artigiana e la natura hanno avuto un peso importante nella sua vita. Quando aveva 20 anni, si è qualificata come insegnante d'arte presso l'Avroy Institute di Liegi, in Belgio, e ha iniziato a insegnare. Nel 1986 si è specializzata in un settore insolito e globalmente ricercato diventando incisore di fucili da caccia al Léon-Mignon Institute di Liegi. Ha lavorato su un'ampia gamma di opere artistiche: ha creato poster per concorsi, disegni di animali, ha organizzato mostre di schizzi a matita e tanto altro. Il lavoro di Françoise, è sempre stato percorso da un leitmotiv: produrre opere d'arte uniche e realistiche, con una straordinaria attenzione

into an unusual and globally sought-after hunting weapon engraver Institute in Liège.

eine große Liebe zum Detail zeigen. 1988 wandte sie sich der Welt des Tafelgeschirrs zu, insbesondere für Hotels und Restaurants. Sie arbeitet aktiv an der Gestaltung und der vollständigen Entwicklung personalisierter Designs auf Porzellan für angesehene Kunden in der ganzen Welt. Ihr Portfolio umfasst das London Hilton Hotel, Relais & Châteaux, Radisson Kuwait, Disneyland Paris, das Colosseo Hotel im Europapark, Casino Barrière, den Großherzoglichen Palast in Luxemburg, Sterne-Restaurants wie das von Léa Linster sowie einen Katalog mit Designs, die bei ihren Kunden zu wohlverdientem Erfolg führten. Im Jahr 2010 schloss sie sich dem jungen Team bei RAK Porcelain Europe an und hat seither viele hervorragende Designs für eine große Zahl europäischer Unternehmen entworfen. Auf diese Weise kann sie ihr Talent dazu nutzen, außergewöhnliche und anerkannte Werke zu schaffen.

único, con una gran atención al detalle. En 1988 entró en el mundo del diseño de vajillas y artículos de mesa, en especial para hoteles y restaurantes, donde fue particularmente activa en la creación y el desarrollo en todas sus fases del diseño de porcelanas por encargo de clientes prestigiosos de todas partes del mundo. Entre sus clientes figuran el Hotel Hilton de Londres, Relais & Châteaux, Radisson Kuwait, Disneyland Paris, el Hotel Colosseo de Europa Park, Casino Barrière, el Palacio del Gran Ducado de Luxemburgo y restaurantes de primera categoría como el Léa Linster, y posee un amplio catálogo de diseños que goza de una merecida reputación entre sus clientes. Desde su ingreso en 2010 al joven equipo de RAK Porcelain Europe, ha creado una multitud de sorprendentes diseños para una gran variedad de establecimientos europeos. Todo ello es prueba fehaciente de su talento para crear obras merecedoras de aclamación.

al dettaglio. Nel 1988 è passata al mondo dei servizi per la tavola, in particolare per gli hotel e i ristoranti. È attiva nella creazione e nello sviluppo completo di design personalizzati su porcellana per prestigiosi clienti in tutto il mondo. Il suo portfolio comprende il London Hilton Hotel, Relais & Châteaux, Radisson Kuwait, Disneyland Paris, il Colosseo Hotel all'Europa Park, il Casino Barrière, il Palazzo Granducale di Lussemburgo, ristoranti stellati come Léa Linster, e un catalogo di design che le hanno valso il meritato successo con i suoi clienti. È entrata a far parte dell'equipe di RAK Porcelain Europe nel 2010, e da allora ha prodotto tantissimi design eccezionali per un'ampia varietà di strutture in Europa. Questo le consente di sfruttare il proprio talento per creare lavori straordinari e acclamati.

Mikaela Dörfel



En

For Mikaela Dörfel, “every design must have its own personality”. Mikaela Dörfel grew up in Finland, where she developed a fascination for Scandinavian shapes. Settled in an ancient farm surrounded by horses and meadows dotted with small lakes, her design takes its inspiration from nature itself, underpinned by a defined structure. She has also based her design studio there, to the north of Hamburg for over 15 years, and she works for brands sold in Europe, Asia and the United States. “Of course, a collection begins its life as a concept, but from that moment on every single detail counts in creating it. The strength of the concept is its simplicity and accessibility. The concept must inspire, awaken the senses, function independently and do justice to the natural materials”. A concept responds to a utilitarian need, and is born from the marriage of understanding shapes and thinking logically to create a product which is both stylish and functional. Making models is still a very important step in creating the collection, as this is the stage where every detail can

Fr

Pour Mikaela Dörfel, « chaque design doit posséder sa personnalité propre ». Mikaela Dörfel a grandi en Finlande d'où elle garde une fascination des formes scandinaves. Etablie dans une ancienne ferme entourée de chevaux et de prairies parsemées d'étangs, son design s'inspire directement de la nature soutenue par une structure claire. Son studio de création se trouve là, au nord de Hambourg installé depuis plus de 15 ans et travaille pour des marques distribuées en Europe, en Asie et aux Etats-Unis. « Bien sûr, une collection naît à partir d'une idée, mais ensuite chaque détail compte pour la réaliser. La simplicité du concept et son évidence font sa force. Le concept doit inspirer, éveiller des sensations, fonctionner de manière indépendante et rendre justice au matériau employé de façon naturelle ». Un concept répond à un besoin utilitaire et naît de la combinaison d'une sensibilité des formes, alliée à la réflexion logique pour créer un produit aussi design que fonctionnel. La création des maquettes reste une étape très importante dans le façonnage d'une collection puisqu'elle permet de parfaire chaque petit détail.

Mikaela grew up in Finland, Scandinavian shapes. Her nature itself, underpinned by



be perfected. Mikaela Dörfel adopts a tactile approach to her work. She likes to touch the porcelain with her own hands to ensure the shapes function well in daily use. “Errors are often easier to detect through touch.” Dörfel’s aim is to do justice to the quality of the material used. Her modern, elegant style seeks to find harmony between the tension of straight lines and curves. Her intuition for shapes is paired with a deep knowledge and understanding of the materials and production methods used, both new and old. Mikaela Dörfel has an understanding of materials and markets. Her work is characterised by creativity and determination. Her love of shape drives her to create collection pieces which bypass trends in favour of longevity. Her work has already been recognised with a number of design awards. Mikaela’s style is an example of timeless elegance and innovation, while still remaining extremely practical.

Mikaela Dörfel cultive une approche tactile. Elle aime sentir la porcelaine sous ses doigts pour vérifier la fonctionnalité des formes dans leur utilisation quotidienne. « Les erreurs sont parfois plus faciles à détecter grâce au toucher. » Mikaela Dörfel cherche à rendre justice à la qualité du matériau employé. Son style moderne et élégant cherche l'harmonie entre lignes de tension et courbes. Son intuition pour les formes va de pair avec sa connaissance profonde des matériaux et des méthodes de production anciennes ou modernes. Mikaela Dörfel possède une connaissance des matériaux et des marchés. Sa créativité et son exigence caractérisent son travail. Son amour des formes la conduit à créer des pièces de collection qui évitent les modes et s'inscrivent dans la longévité. Son style fait preuve d'une élégance atemporelle, innovante et reste pourtant toujours excessivement pratique. Certaines de ses collections vivent depuis quelques dizaines d'années.

De

Nach Ansicht von Mikaela Dörfel „muss jedes Design seine eigene Persönlichkeit besitzen.“ Mikaela Dörfel ist in Finnland aufgewachsen, woher sie sich eine Vorliebe für skandinavische Formen bewahrt hat. Sie hat sich in einem alten Bauernhaus, umgeben von Pferden und Weiden mit verstreuten Weihern niedergelassen. Die Inspiration für ihr Design kommt unmittelbar aus der Natur und stützt sich auf eine klare Struktur. Ihr Designstudio befindet sich seit mehr als 15 Jahren im Norden von Hamburg und arbeitet für Marken in ganz Europa, Asien und den USA. „Sicher, eine Kollektion wird aus einer Idee geboren, aber dann zählt jedes Detail, um sie umzusetzen. Die Einfachheit und Klarheit des Konzepts machen die Stärke aus. Das Konzept muss inspirieren, Empfindungen wachrufen, auf unabhängige Weise funktionieren und dem eingesetzten Material gerecht werden. Ein Konzept trägt einem Verwendungszweck Rechnung und wird aus der Kombination einer Sensibilität für Formen in Verbindung mit logischen Überlegungen zur Schaffung eines Produkts geboren, das Design mit Funktionalität verbindet. Die Erstellung von Modellen ist eine sehr bedeu-

Es

Para Mikaela Dörfel, “cada diseño debe tener su propia personalidad”. Mikaela Dörfel creció en Finlandia, de donde nace su fascinación por las formas escandinavas. Afincada en una antigua granja rodeada de caballos y praderas llenas de estanques, su diseño se inspira directamente en la naturaleza sostenida por una estructura clara. Su estudio de creación se encuentra al norte de Hamburgo, donde lleva instalada desde hace más de 15 años y donde trabaja para marcas de Europa, Asia y Estados Unidos. “Obviamente, toda colección nace a partir de una idea, pero cada detalle es importante para poder llevarla a la práctica. La simplicidad del concepto y su evidencia son su punto fuerte. El concepto debe inspirar, despertar sensaciones, funcionar de forma independiente y hacer justicia al material empleado de manera natural”. Un concepto responde a una necesidad utilitaria y nace de la combinación de una sensibilidad de las formas, unida a la reflexión lógica para crear un producto y un diseño funcional. La creación de las maque-

It

Per Mikaela Dörfel “ogni design deve possedere una propria personalità”. Mikaela Dörfel è cresciuta in Finlandia, da cui ha origine il suo fascino per le forme scandinave. Stabilitasi in un’antica fattoria circondata da cavallini e praterie disseminate di stagni, il suo design s’ispira direttamente alla natura sostenuta da una struttura chiara. Il suo studio di creazione si trova a nord di Amburgo da oltre 15 anni e lavora per marchi distribuiti in Europa, Asia e Stati Uniti. “Ovviamente, una collezione prende vita da un’idea, ma ogni dettaglio diviene poi importante per la sua realizzazione. La semplicità del concetto e la sua evidenza sono la sua forza. Il concetto deve ispirarsi, risvegliare delle sensazioni, funzionare in maniera indipendente e rendere giustizia al materiale utilizzato in modo naturale”. Un concetto risponde a un’esigenza utilitaria e, nasce dalla combinazione di una sensibilità delle forme, alleata al riflesso logico per creare un prodotto sia di design che funzionale. Ella ama sentire la porcellana sotto le dita per verificare la funzionalità delle

where she developed a fascination for design takes its inspiration directly from a defined structure.

tende Etappe bei der Gestaltung einer Kollektion, denn sie erlaubt es, jedes kleinste Detail zu perfektionieren. Mikaela Dörfel pflegt eine taktile Herangehensweise. Sie liebt es, das Porzellan mit ihren Fingern zu ertasten, um die Funktionalität der Formen für die tägliche Verwendung zu prüfen. „Fehler sind manchmal leichter durch Anfassen zu entdecken.“ Ihr moderner und eleganter Stil versucht Spannungslinien und Kurven harmonisch miteinander zu verbinden. Ihre Intuition für Formen geht mit ihren umfassenden Kenntnissen über Materialien und alte oder moderne Produktionsverfahren einher. Dörfel kennt die Materialien und die Märkte. Durch ihre Liebe für Formen hat sie Kollektionsstücke entworfen, die Modeerscheinungen umgehen und auf Langlebigkeit ausgerichtet sind. Einige ihrer Kollektionen gibt es bereits seit Jahrzehnten. Der Stil von Mikaela Dörfel beweist eine zeitlose, innovative Eleganz, die jedoch stets außerordentlich praktisch bleibt.

tas constituye una etapa muy importante en la elaboración de una colección, ya que permite perfeccionar cada pequeño detalle. Mikaela Dörfel aboga por un enfoque táctil. Le gusta sentir la porcelana entre sus dedos para corroborar la funcionalidad de las formas con un uso diario. “En ocasiones, los errores son más fáciles de detectar a través del tacto”. Mikaela Dörfel conoce a la perfección los materiales y el mercado. Su trabajo se caracteriza por la creatividad y la exigencia. Su amor por las formas la lleva a crear piezas de colección que evitan las modas y que se inscriben en la longevidad. Algunas de sus colecciones perduran durante décadas. Su trabajo ha sido recompensado con numerosos premios de diseño. El estilo de Mikaela Dörfel da fe de una elegancia atemporal, innovadora y excesivamente práctica.

forme nel loro utilizzo quotidiano. “Gli errori sono talvolta più facili da rilevare grazie al tatto”. Mikaela Dörfel cerca di rendere giustizia alla qualità del materiale impiegato. Il suo stile elegante e moderno cerca l’armonia tra linee di tensione e curve. La sua intuizione per le forme va di pari passo con la sua conoscenza profonda dei materiali e dei metodi di produzione antichi o moderni. Mikaela Dörfel conosce i materiali e i mercati. La sua creatività ed il rigore, caratterizzano il suo lavoro. Il suo amore per le forme, la porta a creare pezzi da collezione che evitano le mode in favore della longevità. Alcune delle sue collezioni sono ancora attuali da alcune decine d’anni. Il suo lavoro, è già stato ricompensato da numerosi premi di design. Lo stile di Mikaela Dörfel è prova di un’eleganza senza tempo, innovativa, che rimane comunque estremamente pratica.

ALLSPICE

En

The sleek, pioneering style of the ALLSPICE series is the perfect match for sophisticated culinary creations.

Fr

Le style épuré et novateur de la série ALLSPICE est propice à des créations culinaires sophistiquées.

De

Der schlichte und moderne Stil der Serie ALLSPICE unterstützt die Komplexität Ihrer kulinarischen Kreationen.

Es

El estilo depurado e innovador de la serie ALLSPICE es perfecto para las creaciones culinarias más sofisticadas.

It

Lo stile essenziale e innovativo della serie ALLSPICE si addice a delle creazioni culinarie sofisticate.





PORCELAIN:
SPRP3BW & SPSP30
CUTLERY: FINE

ALLSPICE

CHIVES



Square plate, 3 round indents
Assiette carrée,
3 encoches rondes
Teller quadratisch,
3 runde Flächen
Plato cuadrado,
3 estanques redondos
Piatto quadrato,
3 inserti rotonde

SPCH30 30 cm / 11.80"



ANGELICA

Square plate, 2 oval indents
Assiette carrée, 2 encoches ovales
Teller quadratisch, 2 ovale Flächen
Plato cuadrado, 2 estanques ovales
Piatto quadrato, 2 inserti ovale

SPAN30 30 cm / 11.80"



Round bowl



Bol rond
Schale rund
Bol redondo
Coppetta rotonda

SPCB32 14 cm - 3.5 cm - 32 cl
5.50" - 1.40" - 10.80 oz

SPCB20 11 cm - 3.5 cm - 20 cl
4.35" - 1.40" - 6.75 oz

SPCB11 8 cm - 3.5 cm - 11 cl
3.15" - 1.40" - 3.70 oz



FENNEL

Square plate, 2 half-moon indents
Assiette carrée,
2 encoches demi-lune
Teller quadratisch,
2 Flächen Halbmond
Plato cuadrado,
2 estanques media luna
Piatto quadrato,
2 inserti mezzaluna

SPFN30 30 cm / 11.80"



Cover for plate
Cloche pour assiette
Cloche für Teller
Campana para plato
Coperchio per piatto

SPLD01 13 cm / 5.10"



LAVENDER

Square plate, 1 oval indent
Assiette carrée, 1 encoche ovale
Teller quadratisch, 1 ovale Fläche
Plato cuadrado, 1 estanque oval
Piatto quadrato, 1 inserto ovale

SPLV30 30 cm / 11.80"



TARRAGON

Square plate, 4 compartments
Assiette carrée, 4 compartiments
Teller quadratisch, 4 Vertiefungen
Plato cuadrado, 4 compartimentos
Piatto quadrato, 4 compartimenti

SPSP4B 30 cm / 11.80"



**THYME****Rectangular tray,
3 compartments**

Plat rectangulaire,
3 compartiments
Platte rechteckig,
3 Vertiefungen
Fuente rectangular,
3 compartimentos
Vassoio rettangolare,
3 compartimenti

SPRP3B 38 x 18 cm
14.95 x 7.10"

**PAPRIKA****Rectangular tray,
3 compartments**

Plat rectangulaire,
3 compartiments
Platte rechteckig,
3 Vertiefungen
Fuente rectangular,
3 compartimentos
Vassoio rettangolare,
3 compartimenti

SPRP3I 37 x 12.5 cm
14.55 x 4.90"

**CURRY****Square tray, 4 compartments**

Plat carré, 4 compartiments
Platte quadratisch, 4 Vertiefungen
Fuente cuadrado, 4 compartimentos
Vassoio quadrato, 4 compartimenti

SPSP4I 30 cm / 11.80"

**ANIS****Rectangular tray for
4 cups without handle**

Plat rectangulaire pour
4 tasses sans anse
Platte rechteckig für
4 Tassen ohne Henkel
Fuente rectangular para
4 tazas sin asa
Vassoio rettangolare per
4 tazze senza manici

SPRP4BW 36 x 11 cm
14.15 x 4.35"

**JUNIPER****Rectangular tray for
3 cups without handle**

Plat rectangulaire pour
3 tasses sans anse
Platte rechteckig für
3 Tassen ohne Henkel
Fuente rectangular para
3 tazas sin asa
Vassoio rettangolare per
3 tazze senza manici

SPRP3BW 30 x 11 cm
11.80 x 4.35"



ALLSPICE



MUSTARD

Rectangular tray for 4 cups 7 cl without handle

Plat rectangulaire pour 4 tasses 7 cl sans anse
Platte rechteckig für 4 Tassen 7 cl ohne Henkel
Fuente rectangular para 4 tazas 7 cl sin asa
Vassoio rettangolare per 4 tazze 7 cl senza manici

SPRP4BI 37 x 11 cm
14.55 x 4.35"



CINNAMON

Rectangular plate, 1 round indent

Plat rectangulaire, 1 encoche ronde
Teller rechteckig, 1 runde Fläche
Plato rectangular, 1 estanque redondo
Piatto rettangolare, 1 inserto rotondo

SPRR29 29 x 22 cm
11.40 x 8.65"



BASIL

Cup without handle

Tasse sans anse
Tasse ohne Henkel
Taza sin asa
Tazza senza manici

SPCU09 9 cl / 3.05 oz

SPCU07 7 cl / 2.35 oz



CORIANDRE

Rectangular plate, 1 square indent

Assiette rectangulaire, 1 encoche carrée
Teller rechteckig, 1 quadratische Fläche
Plato rectangular, 1 estanque cuadrado
Piatto rettangolare, 1 inserto quadrato

SPRS29 29 x 22 cm
11.40 x 8.65"



PEPPER

Rectangular presentation tray

Plat rectangulaire de présentation
Präsentationsplatte rechteckig
Fuente rectangular de presentación
Vassoio da portata rettangolare

SPRP30 30 x 11 cm
11.80 x 4.35"

SPRP17 17.5 cm x 12 cm
6.85 x 4.80"



VANILLA

Oval flat plate

Assiette plate ovale
Teller flach oval
Plato llano oval
Piatto piano ovale

SPEY35 35 x 26 cm / 13.80 x 10.25"



SPEY19 19 x 14 cm / 7.50 x 5.50"



CAYENNE

Oval flat plate

Assiette plate ovale
Teller flach oval
Plato llano oval
Piatto piano ovale

SPEG36 34 x 28 cm / 13.40 x 11"



SPEG19 19 x 16 cm / 7.50 x 6.30"



SESAME

**Square plate,
1 rectangular indent**
Assiette carrée,
1 encoche rectangulaire
Teller quadratisch,
1 rechteckige Fläche
Plato cuadrado,
1 estanque rectangular
Piatto quadrato,
1 inserto rettangolare

SPDP30 30 cm / 11.80"



SPDP19 19 cm / 7.50"

**CILANTRO**

Round flat plate
Assiette plate ronde
Teller flach rund
Plato llano redondo
Piatto piano rotondo

SPCP29 29 cm / 11.40"

**PEPPERMINT**

**Square plate,
1 oval indent**
Assiette carrée,
1 bassin ovale
Teller quadratisch,
1 ovale Fläche
Plato cuadrado,
1 estanque oval
Piatto quadrato
1 inserto ovale

SPSO30 30 cm / 11.80"

**TAMARIND**

**Oval plate,
1 rectangular indent**
Plat ovale,
1 encoche rectangulaire
Platte oval,
1 rechteckige Fläche
Fuente oval,
1 estanque rectangular
Piatto ovale
1 inserto rettangolare

SPTM30 30 x 12 cm
11.80 x 4.70"

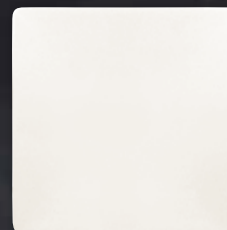
**GINGER**

Square plate
Assiette carrée
Teller quadratisch
Plato cuadrado
Piatto quadrato

SPSP30 30 cm / 11.80"



ALLSPICE

GINGER

Square plate

Assiette carrée
Teller quadratisch
Plato cuadrado
Piatto quadrato

SPSP29 29 cm / 11.40"



SPSP27 27 cm / 10.65"



SPSP25 25 cm / 9.85"



SPSP21 21 cm / 8.25"



SPSP14 14 cm / 5.50"

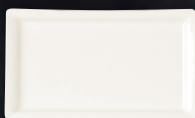
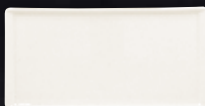
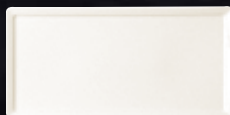
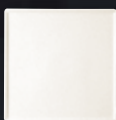

WASABI

Rectangular plate

Plat rectangulaire
Platte rechteckig
Fuente rectangular
Piatto rettangolare

SPRP28 28 x 14 cm

11 x 5.50"

SPRP25 25.5 x 12.5 cm

10 x 4.95"

OPSP24 24 x 14 cm

9.45 x 5.50"



CURCUMA

Square bowl

Bol carré
Schale quadratisch
Bol cuadrado
Coppetta quadrata

SPSB22 22 cm / 8.65"



SPSB15 15 cm / 5.90"

SPSB13 13 cm / 5.10"

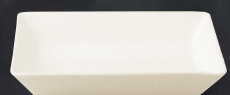
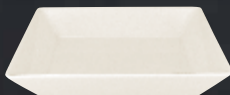
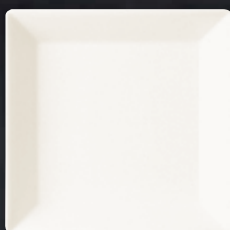

SAFFRON

Rectangular bowl

Bol rectangulaire
Schale rechteckig
Bol rectangular
Coppetta rettangolare

SPRB19 19 x 14.5 cm - 50 cl

7.50 x 5.75" - 16.90 oz



Pieces per box
Pièces par boîte
Stück pro Karton
Piezas por caja
Pezzi per scatola





Rectangular tray, 2 indents*
 Plat rectangulaire, 2 empreintes*
 Platte rechteckig, 2 Ringe*
 Fuente rectangular, 2 estancques*
 Vassoio rettangolare, 2 inserti*

SPRP28IN 28 x 14 cm
 11 x 5.50"

SPRP18IN 18 x 14 cm
 7.10 x 5.50"



Rectangular tray, 3 indents*
 Plat rectangulaire, 3 empreintes*
 Platte rechteckig, 3 Ringe*
 Fuente rectangular, 3 estancques*
 Vassoio rettangolare, 3 inserti*

SPRP28IN3 28 x 14 cm
 11 x 5.50"

SPRP24IN 24 x 14 cm
 9.45 x 5.50"



* See all the possible combinations in the chapter "Cups and Saucers"

* Voir toutes les combinaisons possible au chapitre «Cups and Saucers»

* Alle möglichen Kombinationen im Kapitel „Cups and Saucers“

* Ver todas las posibles combinaciones en el capítulo "Cups and Saucers"

* Vedi tutte le combinazioni possibili nel capitolo "Cups and Saucers"



CHILLI

Bowl

Bol
 Schale
 Bol
 Coppetta

SPCU18 7.5 cm - 6 cm - 18 cl
 2.95" - 2.35" - 6.10 oz



NIGELLA

Crater bowl

Bol cratère
 Krater Schale
 Bol crater
 Coppetta cratere

SPCB33 22.5 cm - 7 cm - 33 cl
 8.80" - 2.75" - 11.15 oz



Fountain bowl

Bol fontaine
 Fontäne Schale
 Bol fuente
 Coppetta fontana

SPFB33 22.5 cm - 7 cm - 33 cl
 8.80" - 2.75" - 11.15 oz



BEAN

Coffee cup

Tasse à café
 Kaffeetasse
 Taza a café
 Tazza da caffè

SPCU27 5.3 cm - 27 cl
 2.10" - 9.15 oz



Saucer

Soucoupe
 Untere
 Platillo
 Piattino

SPSA14 14.2 cm / 5.60"



ANNA

En

The charming ANNA series has been created by Mikaela Dörfel to set off perfectly the delicious dishes of yesteryear and tomorrow, with its curves and contours, glorifying culinary traditions.

Fr

Créée par Mikaela Dörfel pour mettre en scène les bons petits plats d'autrefois et de demain, ANNA est une série toute en charme et rondeurs magnifiant les traditions culinaires.

De

ANNA ist durch die Hand von Mikaela Dörfel entstanden, um die guten kleinen und großen Gerichte von gestern aber auch von morgen in Szene zu setzen. Durch die Serie mit ihrem Charme und ihren runden Formen kommen kulinarische Traditionen voll zur Geltung.

Es

ANNA, creada por Mikaela Dörfel para poner en escena los deliciosos platos de antaño y de mañana, es una serie curva con encanto que magnifica las tradiciones culinarias.

It

Creata da Mikaela Dörfel per mostrare lo spettacolo dei piatti di ieri e di domani, ANNA è una serie all'insegna dell'eleganza e delle rotondità che intende esaltare le tradizioni culinarie.

DESIGN BY MIKAELA DOERFEL





ANNA



Flat plate

Assiette plate
Teller flach
Plato llano
Piatto piano

ANFP31 31 cm / 12.20"



ANFP29 29 cm / 11.40"

ANFP27 27 cm / 10.65"

ANFP24 24 cm / 9.45"



ANFP21 21 cm / 8.25"

ANFP17 17 cm / 6.70"



Bowl

Bol
Schale
Bol
Copetta

ANBW21 21 cm - 10.5 cm - 230 cl
8.25" - 4.15" - 77.75 oz



ANBW18 18 cm - 9 cm - 140 cl
7.20" - 3.60" - 47.35 oz

ANBW16 16 cm - 8 cm - 100 cl
6.30" - 3.15" - 33.80 oz



ANBW14 14 cm - 5.5 cm - 48 cl
5.60" - 2.15" - 16.25 oz



Deep plate

Assiette creuse
Teller tief
Plato hondo
Piatto fondo

ANDP30 30 cm / 11.80"



ANDP26 26 cm / 10.25"

ANDP24 24 cm / 9.45"



Cereal Bowl

Bol à céréales
Müsli-Schale
Bol a cereales
Coppetta per cereali

ANCB13 13 cm - 8.5 cm - 63 cl
5.10" - 3.35" - 21.30 oz



Oval plate

Assiette ovale
Teller oval
Plato oval
Piatto ovale

ANOP38 38 x 24.5 cm
14.95 x 9.65"

ANOP32 32 x 21 cm
12.60 x 8.25"



ANOP22 22 x 14 cm
8.65 x 5.55"



Soup tureen & lid

Soupière & couvercle
Suppenterrine & Deckel
Sopera & tapa
Zuppiera & coperchio

ANSD26 26 cm - 250 cl
10.25" - 84.55 oz

ANSD23 23 cm - 230 cl
9.05" - 77.75 oz



Lid for soup tureen

Couvercle pour soupière
Deckel für Suppenterrine
Tapa para sopra
Coperchio per zuppiera

ANSD26LD > **ANSD26**

ANSD23LD > **ANSD23**



**Breakfast cup**

Tasse à déjeuner
Frühstückstasse
Taza desayuno
Tazza da colazione

ANCU36 9 cm - 36 cl
3.60" - 12.15 oz

**Coffee/tea cup**

Tasse à café/thé
Kaffee-/Teetasse
Taza a café/té
Tazza da caffè/tè

ANCU23 9 cm - 23 cl
3.60" - 7.80 oz

**Cappuccino cup**

Tasse à cappuccino
Cappuccinotasse
Taza cappuccino
Tazza da cappuccino

ANCU28 8 cm - 28 cl
3.25" - 9.45 oz

**Coffee cup**

Tasse à café
Kaffeetasse
Taza a café
Tazza da caffè

ANCU20 8 cm - 20 cl
3.25" - 6.75 oz

**Saucer**

Soucoupe
Untere
Platillo
Piattino

**ANSA15 > ANCU36 / ANCU28 /
ANCU23 / ANCU20**

15.6 cm / 6.15"

**Espresso cup**

Tasse à espresso
Espressotasse
Taza a expreso
Tazza da espresso

ANCU08 6 cm - 8 cl
2.45" - 2.70 oz

**Saucer**

Soucoupe
Untere
Platillo
Piattino

ANSA13 > ANCU08

13 cm / 5.10"



ANNA



Cream soup bowl

Tasse à bouillon
Suppentasse
Bol consommé
Scodella per zuppa

ANCS36 11 cm - 5.5 cm - 36 cl
4.35" - 2.15" - 12.15 oz

12



Creamer

Crémier
Milchkännchen
Lechera
Bricco da latte

ANCR25 25 cl / 8.45 oz

6

ANCR15 15 cl / 5.05 oz

12



Saucer

Soucoupe
Untere
Platillo
Piattino

ANSA17 > ANCS36 / ANGB35

17 cm / 6.70"

12



Sugar bowl & lid

Sucrier & couvercle
Zuckerdose & Deckel
Azucarero & tapa
Zuccheriera & coperchio

ANSU25 25 cl / 8.45 oz

6



Coffee pot & lid

Cafetière & couvercle
Kaffeekanne & Deckel
Cafetera & tapa
Caffettiera & coperchio

ANCP100 100 cl / 33.80 oz

4

ANCP35 35 cl / 11.85 oz

6

Lid for sugar bowl

Couvercle pour sucrier
Deckel für Zuckerdose
Tapa para zucarero
Coperchio per zuccheriera

ANSU25LD

12



Jug

Carafe
Krug
Jarra
Caraffa

ANJU100 100 cl / 33.80 oz

ANJU60 60 cl / 20.30 oz

4

Lid for coffee pot

Couvercle pour cafetière
Deckel für Kaffeekanne
Tapa para cafetera
Coperchio per caffettiera

ANCP100LD > ANCP100

ANCP35LD > ANCP35

12



Teapot & lid

Théière & couvercle
Teekanne & Deckel
Tetera & tapa
Teiera & coperchio

ANTP40 40 cl / 13.55 oz

4



Gravy boat

Saucière
Sauciere
Salsera
Salsiera

ANGB35 35 cl / 11.85 oz

12

ANGB15 15 cl / 5.05 oz

6

Lid for teapot

Couvercle pour théière
Deckel für Teekanne
Tapa para tetera
Coperchio per Teiera

ANTP40LD > ANTP40

12

Pieces per box
Pièces par boîte
Stück pro Karton
Piezas por caja
Pezzi per scatola

**Egg cup**

Coquetier
Eierbecher
Huevera
Portauovo

ANEG01 15,5 cm / 6,15"

**Flower vase**

Vase
Vase
Florero
Vaso

ANFV01 12 cm / 4,70"

**Salt shaker**

Salière
Salzstreuer
Salero
Saliera

ANSS01

**Candle holder**

Bougeoir
Kerzenhalter
Porta velas
Portacandela

ANCH01 15,5 cm / 6,15"

**Pepper shaker**

Poivrier
Pfefferstreuer
Pimentero
Pepiera

ANPS01



AUREA

En

Taking its inspiration from tapas, AUREA includes highly stylish minimalist platters, featuring playful flat or curved shapes for deconstructed dishes. Every portion is a composition of delicacies to be sampled or shared on solid, stylish porcelain.

Fr

Tirant son inspiration des tapas, AUREA propose des plateaux minimalistes très chics et décline des formes ludiques plates ou creuses pour des plats déstructurés. Chaque portion offre une composition de mets à déguster ou à partager dans une porcelaine solide et stylée.

De

Die Idee der Tapas bildete die Inspiration für die sehr eleganten, minimalistischen Platten der AUREA-Serie, die mit kreativen flachen Formen und phantasievollen Vertiefungen für destrukturierte Gerichte spielen. Jeder Abschnitt des stabilen und stilvollen Porzellans wartet auf eine Komposition aus Speisen, die zur Verkostung oder zum gemeinsamen Genuss angeboten werden.

Es

Inspirada en las tapas, AUREA propone platos minimalistas y elegantes, declinando las formas lúdicas y hondas para los platos desestructurados. Cada porción ofrece una composición de platos para degustar o compartir en una porcelana sólida y estilosa a la vez.

It

Ispirandosi alle tapas, AUREA propone vassoi minimalisti di grande eleganza e declina forme ludiche, piane o fonde, per piatti destrutturati. Ogni porzione offre una composizione di prelibatezze da degustare o condividere, in una porcellana solida e ricca di stile.

DESIGN BY GEMMA BERNAL





AUREA



Rectangular plate
Plat rectangulaire
Platte rechteckig
Fuente rectangular
Piatto rettangolare

AURP38 38 x 21 cm
14.95 x 8.25"

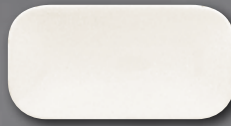

Rectangular plate
Plat rectangulaire
Platte rechteckig
Fuente rectangular
Piatto rettangolare

AURPM22 22 x 11 cm
8.65 x 4.35"



Rectangular plate
Plat rectangulaire
Platte rechteckig
Fuente rectangular
Piatto rettangolare

AURX33 33 x 27 cm
13 x 10.65"



Square plate
Assiette carrée
Teller quadratisch
Plato cuadrado
Piatto quadrato

AUSP33 33 cm / 13"
AUSP30 30 cm / 11.80"
AUSP27 27 cm / 10.65"



AUSP24 24 cm / 9.45"
AUSP22 22 cm / 8.65"

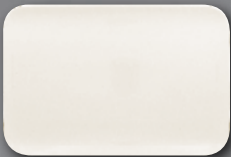

Rectangular plate
Plat rectangulaire
Platte rechteckig
Fuente rectangular
Piatto rettangolare

AURPW33W 33 x 22 cm
13 x 8.65"



AUSP15 15 cm / 5.90"



AUSP11 11 cm / 4.35"



Rectangular plate
Plat rectangulaire
Platte rechteckig
Fuente rectangular
Piatto rettangolare

AURPN33 33 x 11 cm
13 x 4.35"



**Rectangular dish**

Ravier rectangulaire
Schale rechteckig
Rabanera rectangular
Coppetta rettangolare

AURBN33 33 x 11 cm - 3.5 cm - 56.5 cl
13 x 4.35" - 1.40" - 19.10 oz

AURBM22 22 x 11 cm - 3.5 cm - 32.5 cl
8.65 x 4.35" - 1.40" - 11 oz

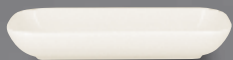
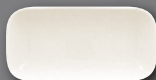
**Rectangular dish**

Ravier rectangulaire
Schale rechteckig
Rabanera rectangular
Coppetta rettangolare

AURBN33BKM 33 x 11 cm - 3.5 cm - 56.5 cl
13 x 4.35" - 1.40" - 19.10 oz

AURBM22BKM 22 x 11 cm - 3.5 cm - 32.5 cl
8.65 x 4.35" - 1.40" - 11 oz

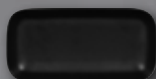
**Square dish**

Ravier carré
Schale quadratisch
Rabanera cuadrada
Coppetta quadrata

AUSB15 15 x 15 cm - 3.5 cm - 32.5 cl
5.90 x 5.90" - 1.40" - 11 oz

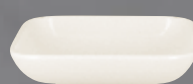

AUSB11 11 x 11 cm - 3.5 cm - 16.5 cl
4.35 x 4.35" - 1.40" - 5.60 oz

**Square dish**

Ravier carré
Schale quadratisch
Rabanera cuadrada
Coppetta quadrata

AUSB15BKM 15 x 15 cm
3.5 cm - 32.5 cl
5.90 x 5.90"
1.40" - 11 oz



AUSB11BKM 11 x 11 cm
3.5 cm - 16.5 cl
4.35 x 4.35"
1.40" - 5.60 oz



AUREA



Rectangular tray, 3 indents

Plat rectangulaire, 3 empreintes
Platte rechteckig, 3 Ringe
Fuente rectangular, 3 estanques
Vassoio rettangolare, 3 inserti

AURT46IN3 46 x 18 cm
18.10 x 7.10"



Rectangular tray, 2 indents

Plat rectangulaire, 2 empreintes
Platte rechteckig, 2 Ringe
Fuente rectangular, 2 estanques
Vassoio rettangolare, 2 inserti

AURT31IN2 31 x 18 cm
12.20 x 7.10"



Round tray, 1 indent

Plat rond, 1 empreinte
Platte rund, 1 Ring
Fuente redondo, 1 estanque
Vassoio rotondo, 1 inserto

AURT20IN 20 cm / 7.85"



Square tray, 1 indent

Plat carré, 1 empreinte
Platte quadratisch, 1 Ring
Fuente rectangular, 1 estanque
Vassoio rettangolare, 1 inserto

AUST18IN 18 cm / 7.10"



Triangular bowl

Bol triangulaire
Schale dreieckig
Bol triangular
Coppetta triangolare

AUTB21 14 cm - 5 cm - 21 cl
5.50" - 1.95" - 7.10 oz

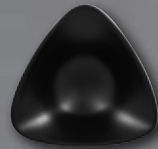

Triangular bowl

Bol triangulaire
Schale dreieckig
Bol triangular
Coppetta triangolare

AUTB21BKM 14 cm - 5 cm - 21 cl
5.50" - 1.95" - 7.10 oz



Oval bowl

Bol ovale
Schale oval
Bol oval
Coppetta ovale

AUOB20 20.5 x 10 cm - 4.5 cm - 20 cl
8.05 x 3.95" - 1.75" - 6.75 oz



Oval bowl

Bol ovale
Schale oval
Bol oval
Coppetta ovale

AUOB20BKM 20.5 x 10 cm
4.5 cm - 20 cl
8.05 x 3.95"
1.75" - 6.75 oz





Duo wave bowl

Bol double vague
Schale doppelwellig
Bol doble onda
Coppetta doppia onda

AUDWB44 12.3 cm - 7.5 cm - 42 cl
4.85" - 2.95" - 14.20 oz



Tri wave bowl

Bol triple vague
Schale dreiwellig
Bol triple onda
Coppetta tripla onda

AUTWB42BKM
12.2 cm - 7.5 cm - 42 cl
4.80" - 2.95" - 14.20 oz



Duo wave bowl

Bol double vague
Schale doppelwellig
Bol doble onda
Coppetta doppia onda

AUDWB44BKM
12.3 cm - 7.5 cm - 42 cl
4.85" - 2.95" - 14.20 oz



Curled bowl

Bol cannelé
Schale gerippt
Bol acanalado
Coppetta scanalata

AUCB20 13.5 cm - 5.6 cm - 20 cl
5.30" - 2.20" - 6.75 oz



Tri wave bowl

Bol triple vague
Schale dreiwellig
Bol triple onda
Coppetta tripla onda

AUTWB42 12.2 cm - 7.5 cm - 42 cl
4.80" - 2.95" - 14.20 oz

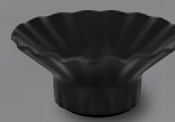
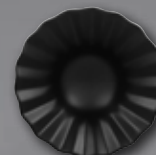

Curled bowl

Bol cannelé
Schale gerippt
Bol acanalado
Coppetta scanalata

AUCB20BKM 13.5 cm - 5.6 cm - 20 cl
5.30" - 2.20" - 6.75 oz



AUREA

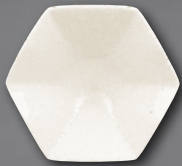

Flower bowl
Bol fleur
Schale in Blumenform
Bol flor
Coppetta fiore

AUFB20 16 cm - 5 cm - 21 cl
6.30" - 1.95" - 7.10 oz



Square bowl
Bol carré
Schale quadratisch
Bol cuadrado
Coppetta quadrata

AUSB20 13 cm - 5 cm - 20 cl
5.10" - 1.95" - 6.75 oz

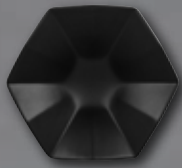

Flower bowl
Bol fleur
Schale in Blumenform
Bol flor
Coppetta fiore

AUFB20BKM 16 cm - 5 cm - 21 cl
6.30" - 1.95" - 7.10 oz



Square bowl
Bol carré
Schale quadratisch
Bol cuadrado
Coppetta quadrata

AUSB20BKM 13 cm - 5 cm - 20 cl
5.10" - 1.95" - 6.75 oz

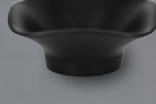

Round bowl
Bol rond
Schale rund
Bol redondo
Coppetta rotonda

AURB25 13.3 cm - 5 cm - 27 cl
5.25" - 1.95" - 9.15 oz



Star bowl
Bol étoile
Schale in Sternform
Bol estrella
Coppetta stella

AUSTB17 13 cm - 4.5 cm - 17 cl
5.10" - 1.75" - 5.75 oz



Round bowl
Bol rond
Schale rund
Bol redondo
Coppetta rotonda

AURB25BKM 13.3 cm - 5 cm - 27 cl
5.25" - 1.95" - 9.15 oz

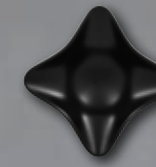

Star bowl
Bol étoile
Schale in Sternform
Bol estrella
Coppetta stella

AUSTB17BKM 13 cm - 4.5 cm - 17 cl
5.10" - 1.75" - 5.75 oz

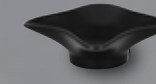

 Pieces per box
Pièces par boîte
Stück pro Karton
Piezas por caja
Pezzi per scatola



B.CONCEPT

En

With B.CONCEPT even the most diverse buffets can be presented harmoniously with four different heights.

Fr

B.CONCEPT permet de présenter les buffets les plus variés de façon toujours harmonieuse sur quatre hauteurs différentes.

De

B.CONCEPT gestattet die Präsentation von sehr vielfältigen Buffets auf harmonische Weise auf vier verschiedenen Höhen.

Es

B.CONCEPT permite presentar los más variados bufés de manera armoniosa en cuatro alturas diferentes.

It

La linea B.CONCEPT consente di presentare i buffet più vari in maniera armoniosa su quattro altezze differenti.





B.CONCEPT



Platter

Plat
Platte
Fuente
Vassoio

LXBS51 51 x 30 cm
20.10 x 11.80"

LXBS30 30 x 26 cm
11.80 x 10.25"



Large wooden stand

Support bois grand modèle
Holzständer groß
Soporte de madera grande
Supporto in legno modello grande

WS51 51 x 30 cm
20 x 11.80"



Small wooden stand

Support bois petit modèle
Holzständer klein
Soporte de madera pequeño
Supporto in legno modello piccolo

WS30 30 x 26 cm
11.80 x 10.25"



Platter black

Plat noir
Platte schwarz
Fuente negro
Vassoio nero

LXBS51BK 51 x 30 cm
20.10 x 11.80"

LXBS30BK 30 x 26 cm
11.80 x 10.25"

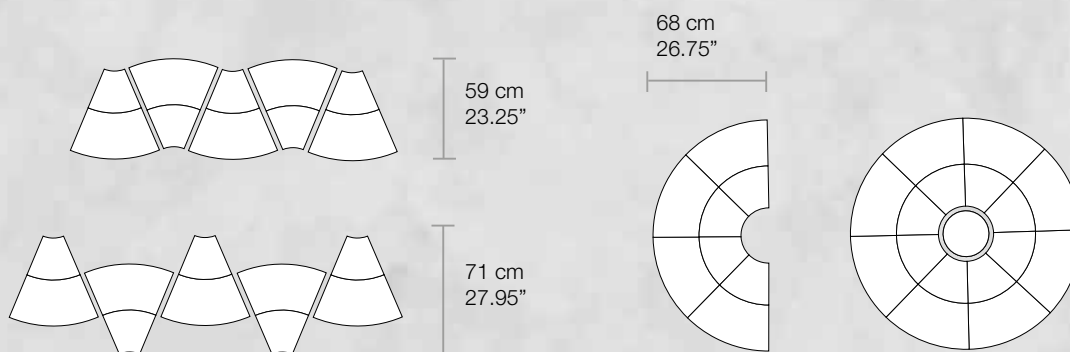
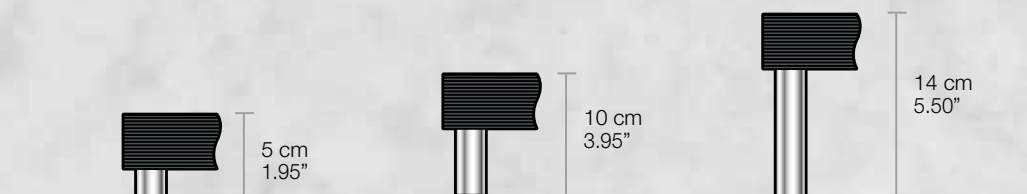

En

Support of varnished wood withstanding abrasion and mechanical shocks, available with 3 sets bases to screw on, 3 heights: 5 cm, 10 cm and 14 cm / 1.95", 3.95" and 5.50"

Fr

Support en bois vernis résistant à l'abrasion et aux chocs mécaniques, livré avec 3 jeux de pieds à visser, 3 hauteurs: 5 cm, 10 cm et 14 cm / 1.95", 3.95" et 5.50"

De

Träger aus lackiertem Holz, das Verschleißerscheinungen und mechanischen Stößen standhält, lieferbar mit 3 Fußsätzen zum Anschrauben, 3 Maße: 5 cm, 10 cm und 14 cm / 1.95", 3.95" und 5.50"

Es

Soporte de madera barnizada, resistente a la abrasión y a los choques mecánicos, se entrega con 3 juegos de papas enroscables, de 3 alturas: 5 cm, 10 cm y 14 cm / 1.95", 3.95" y 5.50"

It

Supporto legno verniciato, resistente all'abrasione e shock meccanico viene consegnato con 3 set di piedi, 3 altezzeras: 5 cm, 10 cm y 14 cm / 1.95", 3.95" y 5.50"



NEW

Platter

Plat
Platte
Fuente
Vassoio

LXBP30 29.5 x 20 cm
11.60 x 7.85"

6



NEW

Wooden tray

Plateau en bois
Holzplatte
Fuente de madera
Vassoio in legno modello

WDTR65 65.5 cm / 25.80"

1



NEW

BANQUET

En

The BANQUET series consists of over 100 items for catering professionals and their daily needs. This series is a perfect combination of functionality, durability and minimalist elegance.

Fr

La série BANQUET se compose de plus de 100 pièces pour les professionnels et leurs besoins quotidiens. Cette série associe à merveille fonctionnalité, robustesse et élégance minimaliste.

De

Die Serie BANQUET besteht aus über 100 Teilen und ist ideal für den professionellen Gebrauch und seine täglichen Anforderungen. Die Serie besticht durch hervorragende Funktionalität, Robustheit und minimalistische Eleganz.

Es

La serie BANQUET se compone de más de 100 piezas para satisfacer las necesidades diarias de los profesionales. Esta serie combina de maravilla funcionalidad, robustez y elegancia minimalista.

It

La serie BANQUET è formata da oltre 100 pezzi dedicati ai professionisti e alle loro esigenze quotidiane. Questa serie unisce con grande equilibrio funzionalità, robustezza ed eleganza minimalista.





BANQUET



Flat plate

Assiette plate
Teller flach
Plato llano
Piatto piano

BAFP31 31 cm / 12.20"

BAFP30 30 cm / 11.80"



BAFP29 29 cm / 11.40"

BAFP28 28 cm / 11"

BAFP27 27 cm / 10.65"

BAFP25 25 cm / 9.85"

BAFP24 24 cm / 9.45"

BAFP23 23 cm / 9.05"



BAFP21 21 cm / 8.25"

BAFP20 20 cm / 7.85"

BAFP19 19 cm / 7.50"

BAFP17 17 cm / 6.70"

BAFP15 15 cm / 5.90"

BAFP13 13 cm / 5.10"



Pizza plate

Assiette à pizza
Pizzateller
Plato pizza
Piatto pizza

BAPP27 27 cm / 10.65"



Oval plate

Plat ovale
Platte oval
Fuente oval
Piatto ovale

BAOP45 45 x 33 cm / 17.70 x 13"



BAOP38 38 x 26 cm / 14.95 x 10.25"

BAOP32 32 x 22 cm / 12.60 x 8.65"



BAOP26 26 x 18.4 cm / 10.25 x 7.25"

BAOP22 22 x 15.5 cm / 8.65 x 6.10"



Deep plate

Assiette creuse
Teller tief
Plato hondo
Piatto fondo

BADP30 30 cm / 11.80"



BADP28 28 cm / 11"

BADP26 26 cm / 10.25"

BADP23 23 cm / 9.05"

BADP19 19 cm / 7.50"



Bowl

Bol
Schale
Bol
Coppetta

BABW14 14 cm - 6 cm - 63 cl
5.50" - 2.35" - 21.30 oz

BABW12 12 cm - 6 cm - 48 cl
4.70" - 2.35" - 16.25 oz



BACS01 10.5 cm - 6 cm - 30 cl
4.15" - 2.35" - 10.15 oz



Steak plate

Assiette à steak
Steakteller
Plato steak
Piatto per bistecca

BAOP30 30 x 25.5 cm
11.80 x 10.05"



Lugged soup bowl

Tasse à bouillon
Suppentasse
Bol consommé
Scodella per zuppa

BACS02 10.5 cm - 6 cm - 30 cl
4.15" - 2.35" - 10.15 oz



Pizza plate

Assiette à pizza
Pizzateller
Plato pizza
Piatto pizza

BAPP33 33 cm / 13"

BAPP32 30.5 cm / 12"



Cream soup bowl, 2 handles

Tasse à bouillon, 2 anses
Suppentasse, 2 Henkel
Bol consommé, 2 asas
Scodella per zuppa, 2 manici

BACS30 10.5 cm - 5.5 cm - 30 cl
4.15" - 2.15" - 10.15 oz

BACS18 8.5 cm - 5 cm - 18 cl
3.35" - 1.95" - 6.10 oz



**Saucer**

Soucoupe
Untere
Platillo
Piattino

BAST01 > BACS30 / BACS02 / BACS01
17 cm / 6.70"

12

**Stackable salad bowl**

Saladier empilable
Salatschale stapelbar
Ensaladera apilable
Insalatiera impilabile

BASB21 21 cm - 7.5 cm - 118 cl
8.25" - 2.95" - 39.90 oz

BASB18 18 cm - 6.5 cm - 72 cl
7.10" - 2.55" - 24.35 oz

BASB16 16 cm - 7 cm - 60 cl
6.30" - 2.75" - 20.30 oz

BASB12 12 cm - 5.5 cm - 25 cl
4.70" - 2.15" - 8.45 oz

12

**Salad bowl**

Saladier
Salatschale
Ensaladera
Insalatiera

BASP31 31 cm - 13 cm - 590 cl
12.20" - 5.10" - 199.50 oz

BASP25 25 cm - 11 cm - 200 cl
9.85" - 4.35" - 67.65 oz

1

BASP20 20 cm - 8 cm - 105 cl
7.85" - 3.15" - 35.50 oz

BASP16 16 cm - 7.5 cm - 67 cl
6.30" - 2.95" - 22.65 oz

BASP14 14 cm - 7 cm - 50 cl
5.50" - 2.75" - 16.90 oz

BASP12 12 cm - 6 cm - 31 cl
4.70" - 2.35" - 10.50 oz

12

**Large mezza bowl**

Grand bol mezza
Mezza Schale groß
Bol mezza grande
Coppetta mezza grande

BAMB17 17 cm - 4 cm - 36 cl
6.70" - 1.55" - 12.15 oz

12

**Small mezza bowl**

Petit bol mezza
Mezza Schale klein
Bol mezza pequeño
Coppetta mezza piccola

BAMB13 13 cm - 4 cm - 17 cl
5.10" - 1.55" - 5.75 oz

6

**Noodle bowl**

Bol à nouilles
Nudelschale
Noodle bol
Coppetta per pasta

BANB21 21 cm - 9 cm - 110 cl
8.25" - 3.55" - 37.20 oz

6



BANQUET



Arabic cup

Tasse arabique
Tasse arabisch
Taza arábiga
Tazza arabe

BAAC16 16 cl / 5.40 oz

BAAC11 11 cl / 3.70 oz

BAAC07 7 cl / 2.35 oz

BAAC06 6 cl / 2.05 oz

BAAC04 4 cl / 1.35 oz



Ristretto cup

Tasse ristretto
RistrettoTasse
Taza ristretto
Tazza ristretto

BANC07 7 cl / 2.35 oz



Saucer

Soucoupe

Untere

Platillo

Piattino

BASA13 > BANC09 / BANC07

13 cm / 5.10"



Non stackable cup

Tasse non empilable
Tasse nicht stapelbar
Taza no apilable
Tazza non impilabile

BANC28 28 cl / 9.45 oz

BANC22 22 cl / 7.45 oz

BANC15 15 cl / 5.05 oz



Saucer

Soucoupe

Untere

Platillo

Piattino

BAST01 > BANC28

17 cm / 6.70"



Stackable cup high

Tasse empilable haute
Tasse stapelbar hoch
Taza apilable alta
Tazza impilabile alta

BACU28 28 cl / 9.45 oz

BACU20 20 cl / 6.75 oz

BACU09 9 cl / 3.05 oz



Stackable cup

Tasse empilable
Tasse stapelbar
Taza apilable
Tazza impilabile

BACU23 23 cl / 7.80 oz

BACU18 18 cl / 6.10 oz



Saucer

Soucoupe

Untere

Platillo

Piattino

BASA15 > BANC22 / BANC15

15 cm / 5.90"



Saucer

Soucoupe

Untere

Platillo

Piattino

BAST01 > BACU28

17 cm / 6.70"



Non stackable cup

Tasse non empilable
Tasse nicht stapelbar
Taza no apilable
Tazza non impilabile

BANC09 9 cl / 3.05 oz



Saucer

Soucoupe

Untere

Platillo

Piattino

BASA15 > BACU23 / BACU20 / BACU18

15 cm / 5.90"





Saucer
Soucoupe
Untere
Platillo
Piattino

BASA13 > BACU09
13 cm / 5.10"
12



Mug
Chope
Becher
Mug
Mug

BAMG36 36 cl / 12.15 oz
12



Mug Flora
Chope Flora
Becher Flora
Mug Flora
Mug Flora

BAMG45 45 cl / 15.20 oz
BAFMG36 36 cl / 12.15 oz
12
BAFMG30 30 cl / 10.15 oz
BAMG26 26 cl / 8.80 oz
6



Saucer
Soucoupe
Untere
Platillo
Piattino

BAST01 > BAMG45
17 cm / 6.70"
12



Stackable mug
Chope empilable
Becher stapelbar
Mug apilable
Mug impilabile

BASM30 30 cl / 10.15 oz
12



Mug Tulip
Chope Tulip
Becher Tulip
Mug Tulip
Mug Tulip

BATMG45 45 cl / 15.20 oz
BATMG30 30 cl / 10.15 oz
12



Mug
Chope
Becher
Mug
Mug

BAMG30 30 cl / 10.15 oz
12



Mug Lotus
Chope Lotus
Becher Lotus
Mug Lotus
Mug Lotus

BALMG30 30 cl / 10.15 oz
6



Strainer for mug Lotus
Filtre pour chope Lotus
Filter für Becher Lotus
Filtro para mug Lotus
Filtro per mug Lotus

BALMG30ST01 8 cm - 6 cm
3.15" - 2.35"
6



Lid for mug Lotus
Couvercle pour chope
Lotus
Deckel für Becher Lotus
Tapa para mug Lotus
Coperchio per mug Lotus

BALMGD1 7.9 cm / 3.10"
6



BANQUET



Coffee pot & lid

Cafetière & couvercle
Kaffeekanne & Deckel
Cafetera & tapa
Caffettiera & coperchio

BACP70 70 cl / 23.65 oz

BACP35 35 cl / 11.85 oz



Lid for coffee pot

Couvercle pour cafetière
Deckel für Kaffeekanne
Tapa para cafetera
Coperchio per caffettiera

BACPLD2 > **BACP70**

BACPLD1 > **BACP35**



Gravy boat

Saucière
Sauciere
Salsera
Salsiera

BAGB35 35 cl / 11.85 oz



BAGB15 15 cl / 5.05 oz



Saucer

Soucoupe
Untere
Platillo
Piattino

BASA15 > **BAGB35**

15 cm / 5.90"

BASA13 > **BAGB15**

13 cm / 5.10"



Teapot & lid

Théière & couvercle
Teekanne & Deckel
Tetera & tapa
Teiera & coperchio

BATP100 100 cl / 33.80 oz

BATP80 80 cl / 27.05 oz

BATP40 40 cl / 13.55 oz



Stackable butter ramekin

Ramequin à beurre empilable
Butterschälchen stapelbar
Platillo para mantequilla apilable
Coppetta da burro impilabile

BABR02 8 cm - 3.5 cm - 10 cl

3.15" - 1.40" - 3.40 oz



Stackable butter ramekin

Ramequin à beurre empilable
Butterschälchen stapelbar
Platillo para mantequilla apilable
Coppetta da burro impilabile

BABR03 7 cm - 3 cm - 6 cl

2.75" - 1.20" - 2.05 oz



Creamer

Crémier
Milchkännchen
Lechera
Bricco da latte

BACR35 35 cl / 11.85 oz

BACR25 25 cl / 8.45 oz

BACR15 15 cl / 5.05 oz



BACR05 5 cl / 1.70 oz



Butter ramekin

Ramequin à beurre
Butterschälchen
Platillo para mantequilla
Coppetta da burro

BABR01 6.7 cm - 6 cl / 2.65" - 2.05 oz

BABR05 5 cm / 1.95"



**Butter dish**

Assiette à beurre
Butterteller
Plato mantequilla
Piatto da burro

BABD11 11 x 8 cm / 4.35 x 3.15"

12

**Sumek shaker**

Salière Sumek
Sumekstreuer
Salero Sumek
Saliera Sumek

BASM01

6

**Continental sauce dish**

Plat à sauce continental
Saucenschale continental
Salsera continental
Salsiera continentale

BACD09 9 x 7 cm / 3.55 x 2.75"

12

**Egg cup**

Coquetier
Eierbecher
Huevera
Portauovo

BAEG01

6

**Pepper shaker**

Poivrier
Pfefferstreuer
Pimentero
Pepiera

BAPS01

6

**Sugar bowl & lid**

Sucrier & couvercle
Zuckerdose & Deckel
Azucarero & tapa
Zuccheriera & coperchio

BASU27 27 cl / 9.15 oz

6

**Salt shaker**

Salière
Salzstreuer
Salero
Saliera

BASS01

6

Lid for sugar bowl

Couvercle pour sucrier
Deckel für Zuckerdose
Tapa para azucarero
Coperchio per zuccheriera

BASULD

12

**Sliding sugar pack holder**

Sucrier oblique
pour dosettes
Zuckertütenschale schräg
Azucarero sobres obliqua
Portabustine da zucchero
obliquo

BASH03 11 x 6 cm - 5 cm - 10 cl
4.35 x 2.35" - 1.95" - 3.40 oz

6

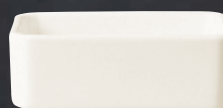
**Sugar pack holder**

Sucrier à sachets
Zuckertütenschale
Azucarero sobres
Portabustine da zucchero

BASH01 11 x 7 cm - 4 cm - 20 cl
4.35 x 2.75" - 1.55" -

6.75 oz

6



BANQUET



Round sugar pack holder

Sucrier rond à sachets
Zuckertütenschale rund
Azucarero sobres redondo
Contenitore rotondo per pacco di zucchero

BASH02 8.5 cm - 23 cl
3.35" - 7.80 oz

12



Cigar ashtray

Cendrier à cigares
Zigarrenascher
Cenicero a puros
Portacenere per sigari

BACA01 21 x 16 cm
8.25 x 6.30"

2



Toothpick holder

Conteneur cure-dents
Zahnstocherhalter
Palillero
Portastecchini

BATH01 7 cl / 2.35 oz

12



Ashtray

Cendrier
Ascher
Cenicero
Portacenere

BAAT01 11 cm / 4.35"

12



Menu label holder

Porte-menu
Menühalter
Soporte menú
Portamenu

BAMH01 10.5 cm - 7.5 cm
4.15" - 2.95"

12



Napkin holder

Porte serviette
Serviettenhalter
Servilletero
Portatovaglioli

BATW01 15 x 11 cm
6 x 4.35"

BATW02 17 x 8 cm
6.60 x 3.15"

6



Napkin holder

Porte-serviette
Serviettenhalter
Servilletero
Portatovaglioli

BANH01 10.5 cm - 7.5 cm
4.15" - 2.95"

12



Candle holder

Bougeoir
Kerzenhalter
Porta velas
Portacandela

BACH01

12



Napkin ring

Anneau à serviette
Serviettenring
Anillo servilletero
Portatovagliolo

BANR01 6 cm / 2.35"

12



Ashtray

Cendrier
Ascher
Cenicero
Portacenere

BAAT02

12



Flower vase

Vase
Vase
Florero
Vaso

BAFV01 15.5 cm / 6.10"

6



Rectangular ashtray

Cendrier rectangulaire
Ascher rechteckig
Cenicero rectangular
Portacenere rettangolare

BAAT03



Shell dish

Recipient coquillage
Schale in Muschelform
Concha plato
Coppetta conchiglia

BASO01 14 x 12.5 cm
5.45 x 4.95"



Windproof square ashtray

Cendrier anti-vent
Ascher windgeschützt
Cenicero contravientos
Portacenere - protetto del vento

BAAT11 11.5 x 11.5 cm
4.55 x 4.55"



Oval shell dish

Coupelle coquillage
Schale in Muschelform
Concha plato
Coppetta conchiglia

BASO02 13 x 8.5 cm
5" x 3.35"



Cigar ashtray rectangular

Cendrier à cigares rectangulaire
Zigarrenascher rechteckig
Cenicero del cigarro rectangular
Portacenere rettangolare per sigari

BACA02 20 x 16.5 cm
7.85 x 6.50"



Olive dish

Plat à olives
Oliven Teller
Oliva plato
Piatto da olive

BAOL01 11.5 x 9 cm
4.55 x 3.50"



Flower dish

Coupelle fleur
Schale in Blumenform
Concha flor
Coppetta fiore

BAFD01 9 cm - 15 cl
3.55" - 5.05 oz



Pieces per box
Pièces par boîte
Stück pro Karton
Piezas por caja
Pezzi per scatola

BARISTA



En

BARISTA offers a range of cups in all sizes, manufactured using our exclusive material, highly effective at retaining temperature. The ergonomically-designed handles are easy to hold and six of the seven cups can be combined with the same saucer, to help control outlay and storage costs.

Fr

BARISTA offre un éventail de tasses de toutes tailles fabriquées dans notre matériau exclusif conservant les températures à merveille. Ses anses ergonomiques permettent une manipulation aisée et six des sept tasses se combinent avec la même sous-tasse, de sorte que l'investissement et les coûts de stockage sont maîtrisés.

De

BARISTA bietet ein großes Spektrum an Tassen aller Größen, die aus unserem exklusiven Material hergestellt sind, das die Temperatur besonders gut hält. Durch ihre ergonomischen Henkel können sie bequem gehalten und sechs von sieben Tassen können mit derselben Untertasse kombiniert werden, so dass Anschaffungs- und Lagerkosten in Grenzen gehalten werden.

Es

BARISTA ofrece una amplia variedad de tazas de todos los tamaños fabricadas a base de nuestro material exclusivo que conserva la temperatura a la perfección. Sus asas ergonómicas permiten una fácil manipulación y seis de sus siete tazas se combinan con el mismo plato, para así reducir la inversión y los costes de almacenaje.

It

BARISTA offre una gamma di tazze di tutte le misure fabbricate nel nostro esclusivo materiale che conserva perfettamente le temperature. Le sue anse ergonomiche consentono una facile manipolazione e sei delle sette tazze possono essere combinate con la stessa sotto-tazza, in modo da ammortizzare l'investimento e i costi di stoccaggio.



BARISTA



NEW



Saucer for coffee cup

Soucoupe pour tasse à café
Untere für Kaffeetasse
Platillo para taza a café
Piattino per tazza da caffè

CLSA15 15 cm / 5.90"



Coffee cup 15 cl **NEW**

Tasse à café
Kaffeetasse
Taza a café
Tazza da caffè

116CU15 H 5.5 cm - 15 cl
H 2.15" - 5.05 oz



Saucer for espresso cup

Soucoupe pour tasse à espresso
Untere für Espresso tasse
Platillo para taza a expreso
Piattino per tazza da espresso

CLSA13 13 cm / 5.10"



Espresso cup

Tasse à espresso
Espresso tasse
Taza a expreso
Tazza da espresso

116CU08 H 5.3 cm - 8 cl
H 2.10" - 2.70 oz



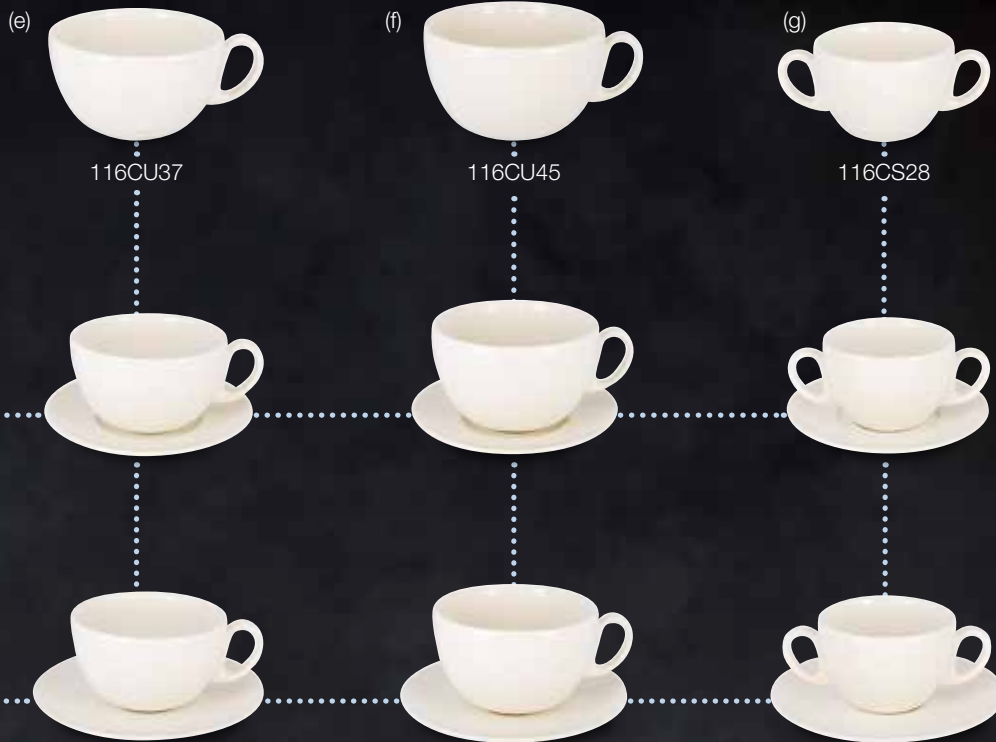



(1) **Universal Saucer**
 Soucoupe universelle
 Kombi Untere
 Piattino universal
 Piattino universale
CLSA01 15 cm / 5.90"
 12

(a) **Coffee cup 20 cl**
 Tasse à café
 Kaffeetasse
 Taza a café
 Tazza da caffè
116CU20 H 6 cm - 20 cl
 H 2.35" - 6.75 oz
 12

(d) **Breakfast cup 37 cl**
 Tasse à déjeuner
 Frühstückstasse
 Taza a desayuno
 Tazza da colazione
116CU37 H 6.5 cm - 37 cl
 H 2.55" - 12.50 oz
 12

(2) **Universal Saucer**
 Soucoupe universelle
 Kombi Untere
 Piattino universal
 Piattino universale
CLSA02 17 cm / 6.70"
 12

(b) **Coffee cup 23 cl**
 Tasse à café
 Kaffeetasse
 Taza a café
 Tazza da caffè
116CU23 H 6.1 cm - 23 cl
 H 2.40" - 7.80 oz
 12

(e) **Breakfast cup 45 cl**
 Tasse à déjeuner
 Frühstückstasse
 Taza a desayuno
 Tazza da colazione
116CU45 H 7.5 cm - 45 cl
 H 2.95" - 15.20 oz
 12

(c) **Coffee cup 28 cl**
 Tasse à café
 Kaffeetasse
 Taza a café
 Tazza da caffè
116CU28 H 6.5 cm - 28 cl
 H 2.55" - 9.45 oz
 12

(f) **Cream soup bowl, 2 handles**
 Tasse à bouillon, 2 anses
 Suppentasse, 2 Henkel
 Bol consomé, 2 asas
 Scodella per zuppa, 2 manici
116CS28 H 6.3 cm - 28 cl
 H 2.50" - 9.45 oz
 12

BLOSSOM **NEW**

En

A floral relief pattern enhances room service meals.

Fr

Un motif floral en relief vient sublimer les repas en chambre.

De

Das erhabene Blumenmotiv sorgt beim Essen auf dem Zimmer für feine Eleganz.

Es

Un motivo floral en relieve exalta las comidas en la habitación.

It

Il suo motivo floreale in rilievo renderà sublime l'esperienza di un pasto in camera.





BLOSSOM **NEW**



Round flat plate

Assiette plate ronde
Teller flach rund
Plato llano redondo
Piatto piano rotondo

CLFP33D183 33 cm / 13"

CLFP31D183 31 cm / 12.20"



CLFP29D183 29 cm / 11.40"

CLFP28D183 28 cm / 11"

CLFP27D183 27 cm / 10.65"

CLFP24D183 24 cm / 9.45"



CLFP21D183 21 cm / 8.25"

CLFP19D183 19 cm / 7.50"

CLFP17D183 17 cm / 6.70"

CLFP15D183 15 cm / 5.90"



Non stackable cup

Tasse non empilable
Tasse nicht stapelbar
Taza no apilable
Tazza non impilabile

CLCU28D183 28 cl / 9.45 oz

CLCU23D183 23 cl / 7.80 oz

CLCU20D183 20 cl / 6.75 oz

CLCU09D183 9 cl / 3.05 oz



Stackable cup

Tasse empilable
Tasse stapelbar
Taza apilable
Tazza impilabile

CLSC23D183 23 cl / 7.80 oz

CLSC20D183 20 cl / 6.75 oz

CLSC09D183 9 cl / 3.05 oz



Saucer for cup

Soucoupe pour tasse
Untere für Tasse
Platillo para taza
Piattino per tazza

CLSA17D183 > **CLCU28D183**

17 cm / 6.70"

CLSA15D183 > **CLCU23D183** / **CLSC23D183** /
CLCU20D183 / **CLSC20D183**

15 cm / 5.90"

CLSA13D183 > **CLCU09D183** / **CLSC09D183**

13 cm / 5.10"



Round deep plate

Assiette creuse ronde
Teller tief rund
Plato hondo redondo
Piatto fondo rotondo

CLDP30D183 30 cm / 11.80"



CLDP26D183 26 cm / 10.25"

CLDP24D183 24 cm / 9.45"

CLDP19D183 19 cm / 7.55"



Extra deep round plate

Assiette extra creuse ronde
Teller extra tief rund
Plato extra hondo redondo
Piatto extra fondo rotondo

CLXD26D183 26 cm - 48 cl
10.25" - 16.25 oz

CLXD23D183 23 cm - 32 cl
9.05" - 10.80 oz



 Pieces per box
Pièces par boîte
Stück pro Karton
Piezas por caja
Pezzi per scatola

You will find a wide range of perfectly compatible accessories among the Classic Gourmet, Banquet and Nano series in the IVORIS catalogue
Vous pouvez trouver une vaste gamme d'accessoires parfaitement compatibles dans les séries Classic Gourmet, Banquet et Nano du catalogue IVORIS.
Die Serien Classic Gourmet, Banquet und Nano im Katalog IVORIS umfassen eine große Auswahl an rundum kompatiblen Accessoires.
Podrá encontrar una amplia gama de accesorios totalmente compatibles en las series Classic Gourmet, Banquet y Nano del catálogo IVORIS.
Le serie Classic Gourmet, Banquet e Nano del catalogo IVORIS offrono una vasta gamma di accessori perfettamente compatibili.



BOUQUET **NEW**

En

This series has a discreet flowery rim that blends easily into all settings.

Fr

La discrète frise fleurie de la série s'insère facilement dans toutes les ambiances.

De

Der diskrete, blumengeschmückte Zierstreifen der Serie passt zu jeder Art von Ambiente.

Es

El discreto friso floral de la serie se integra fácilmente en todos los ambientes.

It

Il discreto fregio fiorito della serie si adatta facilmente a tutte le atmosfere.





BOUQUET **NEW**



Round flat plate

Assiette plate ronde
Teller flach rund
Plato llano redondo
Piatto piano rotondo

CLFP31D184 31 cm / 12.20"



CLFP29D184 29 cm / 11.40"

CLFP28D184 28 cm / 11"

CLFP27D184 27 cm / 10.65"

CLFP24D184 24 cm / 9.45"



CLFP21D184 21 cm / 8.25"

CLFP19D184 19 cm / 7.50"

CLFP17D184 17 cm / 6.70"

CLFP15D184 15 cm / 5.90"



Round deep plate

Assiette creuse ronde
Teller tief rund
Plato hondo redondo
Piatto fondo rotondo

CLDP30D184 30 cm / 11.80"



CLDP26D184 26 cm / 10.25"

CLDP24D184 24 cm / 9.45"

CLDP19D184 19 cm / 7.55"



Extra deep round plate

Assiette extra creuse ronde
Teller extra tief rund
Plato extra hondo redondo
Piatto extra fondo rotondo

CLXD26D184 26 cm - 48 cl
10.25" - 16.25 oz

CLXD23D184 23 cm - 32 cl
9.05" - 10.80 oz



Non stackable cup

Tasse non empilable
Tasse nicht stapelbar
Taza no apilable
Tazza non impilabile

CLCU28D184 28 cl / 9.45 oz

CLCU23D184 23 cl / 7.80 oz

CLCU20D184 20 cl / 6.75 oz

CLCU09D184 9 cl / 3.05 oz



Stackable cup

Tasse empilable
Tasse stapelbar
Taza apilable
Tazza impilabile

CLSC23D184 23 cl / 7.80 oz

CLSC20D184 20 cl / 6.75 oz

CLSC09D184 9 cl / 3.05 oz



Saucer for cup

Soucoupe pour tasse
Untere für Tasse
Platillo para taza
Piattino per tazza

CLSA17D184 > **CLCU28D184**

17 cm / 6.70"

CLSA15D184 > **CLCU23D184** / **CLSC23D184** /
CLCU20D184 / **CLSC20D184**

15 cm / 5.90"

CLSA13D184 > **CLCU09D184** / **CLSC09D184**

13 cm / 5.10"



Pieces per box
Pièces par boîte
Stück pro Karton
Piezas por caja
Pezzi per scatola

You will find a wide range of perfectly compatible accessories among the Classic Gourmet, Banquet and Nano series in the IVORIS catalogue
Vous pouvez trouver une vaste gamme d'accessoires parfaitement compatibles dans les séries Classic Gourmet, Banquet et Nano du catalogue IVORIS.
Die Serien Classic Gourmet, Banquet und Nano im Katalog IVORIS umfassen eine große Auswahl an rundum kompatiblen Accessoires.
Podrá encontrar una amplia gama de accesorios totalmente compatibles en las series Classic Gourmet, Banquet y Nano del catálogo IVORIS.
Le serie Classic Gourmet, Banquet e Nano del catalogo IVORIS offrono una vasta gamma di accessori perfettamente compatibili.



BUFFET

En

The BUFFET series combines design with unflinching toughness. The BUFFET GN range includes all the sizes of hotplates, display cases and refrigerated display shelves in line with the GASTRONORM standards.

Fr

La série BUFFET réunit design et solidité à toutes épreuves. BUFFET GN possède toutes les tailles de chauffe-plats, vitrines, présentoirs réfrigérés et fours de cuisson à la norme GASTRONORM.

De

In der Serie BUFFET verschmelzen attraktives Design und höchste, dauerhafte Robustheit. BUFFET GN verfügt über sämtliche Größen der GASTRONORM-Norm für den Einsatz in Warmhalteplatten, (Kühl-)Vitrinen und Öfen.

Es

La serie BUFFET reúne el diseño y la solidez a toda prueba. BUFFET GN ofrece calentaplatos, vitrinas, expositores refrigerados y hornos de todos los tamaños conforme a la norma GASTRONORM.

It

La serie BUFFET fonde design e solidità assoluta. La linea BUFFET GN presenta le forme e le dimensioni conformi alla norma GASTRONORM relativa all'utilizzo su scaldavivande, vetrine, espositori refrigerati e forni di cottura.





BUFFET



Asymmetric bowl

Bol asymétrique
Schale asymmetrisch
Bol asimétrico
Coppetta asimmetrica

BUBA29 29 cm - 14 cm - 160 cl
11.40" - 5.50" - 54.10 oz

BUBA22 22 cm - 9 cm - 65 cl
8.65" - 3.55" - 22 oz



Soup tureen & lid

Soupière & couvercle
Suppenterrine & Deckel
Sopera & tapa
Zuppiera & coperchio

BUCD27 27 cm - 18 cm - 345 cl
10.70" - 7" - 116.65 oz

BUCD23 24 cm - 16 cm - 217 cl
9.35" - 6.40" - 73.40 oz

BUCD21 21 cm - 14 cm - 137 cl
8.05" - 5.45" - 46.35 oz



BUCD15 15 cm - 58 cl
5.90" - 19.60 oz



Deep coupe plate

Assiette creuse coupe
Teller tief coup
Plato hondo coupe
Piatto fondo senza falda

BUBC46 46 cm - 4 cm - 575 cl
18.10" - 1.55" - 194.45 oz



BUBC36 36 cm - 4 cm - 360 cl
14.15" - 1.55" - 121.75 oz



Square bowl

Bol carré
Schale quadratisch
Bol cuadrado
Coppetta quadrata

BUBS25 25 cm - 416 cl
9.85" - 140.65 oz

BUBS23 23 cm - 300 cl
9.05" - 101.45 oz

BUBS21 21 cm - 200 cl
8.25" - 67.65 oz



Lid for soup tureen

Couvercle pour soupière
Deckel für Suppenterrine
Tapa para sopra
Coperchio per Zuppiera

BULD27 > BUCD27

27.5 cm - 8.5 cm
10.80" - 3.35"



BULD23 > BUCD23

23.5 cm - 8 cm
9.35" - 3.15"



BULD21 > BUCD21

20.5 cm - 7 cm
8.05" - 2.80"



BULD15 > BUCD15

15.5 cm - 5 cm
6.05" - 2.05"





Soup tureen & lid
 Soupière & couvercle
 Suppenterrine & Deckel
 Sopera & tapa
 Zuppiera & coperchio

BUST27 27.5 cm - 18 cm - 350 cl
 10.85 - 7" - 118.35 oz



BUST15 15.5 cm - 10.5 cm - 40 cl
 6" - 4.05" - 13.55 oz



Oval casserole & lid
 Casserole ovale & couvercle
 Ovaler Topf & Deckel
 Cacerola oval & tapa
 Casseruola ovale & coperchio

BUOC35 35 x 22 cm - 245 cl
 13.80 x 8.60" - 82.85 oz



Oval dish
 Plat ovale
 Platte ovale
 Fuente oval
 Vassoio ovale

BUOD37 37 x 26 x 6 cm
 14.55 x 10.25 x 2.30"



BUOD30 30 x 20 x 6 cm
 11.80 x 7.85 x 2.35"



BUOD28 28 x 19 x 6 cm
 11 x 7.50 x 2.35"

BUOD25 25 x 18 x 5 cm
 9.85 x 7.10 x 1.95"



Oval dish
 Plat ovale
 Platte ovale
 Fuente oval
 Vassoio ovale

BUOP56 56 x 21 x 5.5 cm - 220 cl
 22.05 x 8.25 x 2.15" - 74.40 oz



Oval dish
 Plat ovale
 Platte ovale
 Fuente oval
 Vassoio ovale

BUOV40 40 x 23 x 4 cm - 154 cl
 15.75 x 9.05 x 1.55" - 52.05 oz

BUOV36 36 x 22 x 5 cm - 136 cl
 14.15 x 8.65 x 1.95" - 46 oz



BUOV30 29.5 x 17.5 x 5.5 cm - 100 cl
 11.55 x 6.90 x 2.15" - 33.80 oz

BUOV24 24 x 14.3 x 4.2 cm - 54 cl
 9.45 x 5.65 x 1.65" - 18.25 oz



BUFFET



Rectangular pan

Plat rectangulaire
Platte rechteckig
Fuente rectangular
Piatto rettangolare

BURP44 44 x 36 x 6 cm - 500 cl
17.30 x 14.15 x 2.35" - 169.05 oz

BURP37 37 x 30 x 6 cm - 347 cl
14.55 x 11.80 x 2.35" - 117.35 oz



BURP30 30 x 24 x 6.5 cm - 212 cl
11.80 x 9.35 x 2.50" - 71.70 oz



Tray with possible combinations

Plat avec possibilité de combinaisons
Schale mit Kombinationsmöglichkeiten
Fuente y posibilidad de combinación
Vassoio con combinazione possibile

LXDB18 18 x 20 x 6 cm
7.10 x 7.85 x 2.35"



Tray with possible combinations

Plat avec possibilité de combinaisons
Schale mit Kombinationsmöglichkeiten
Fuente y posibilidad de combinación
Vassoio con combinazione possibile

LXBW18 18 x 20 x 6 cm
7.10 x 7.85 x 2.35"



Tray with possible combinations

Plat avec possibilité de combinaisons
Schale mit Kombinationsmöglichkeiten
Fuente y posibilidad de combinación
Vassoio con combinazione possibile

LXRB27 27 x 20 x 6 cm
10.65 x 7.85 x 2.35"



Rectangular tray

Plat rectangulaire
Platte rechteckig
Fuente rectangular
Vassoio rettangolare

BURT52 52 x 24 cm / 20.45 x 9.45"



BURT41 41 x 30 cm / 16.15 x 11.80"

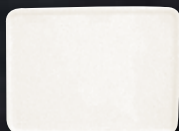

Salad bowl xxl

Saladier xxl
Salatschale xxl
Ensaladera xxl
Insalatiera xxl

BUSB31 31 cm - 17 cm - 600 cl
12.20" - 6.70" - 202.90 oz



Square dish

Ravier carré
Schale quadratisch
Rabanera cuadrada
Coppetta quadrata

BUSD28 28 x 28 x 6 cm - 243 cl
11 x 11 x 2.35" - 82.15 oz



BUSD22 22.5 x 22.5 x 4.5 cm - 100 cl
8.85 x 8.85 x 1.75" - 33.80 oz





Oblong insert

Plat oblong
Schale länglich
Plato oblongo
Piatto oblungo

BUGO40 40 x 27 x 5 cm - 300 cl
15.85 x 10.70 x 1.95" - 101.45 oz

BUGO36 36 cm x 23.7 cm x 5 cm - 250 cl
14.15 x 9.35 x 1.95" - 84.55 oz



Wine cooler

Seau a vin
Weinkühler
Vinoteca
Secchiello per il vino

BUWB25 25 cm - 20 cm - 400 cl
9.80" - 7.85" - 135.25 oz

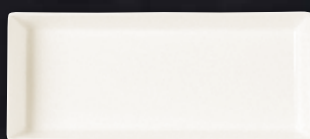

Stackable rectangular long dish

Plat rectangulaire long empilable
Schale rechteckig lang stapelbar
Plato rectangular largo apilable
Coppetta lunga rettangolare impilabile

LXRB47 47 x 20 x 6 cm
18.50 x 7.85 x 2.35"



**Rectangular tray,
2 indents**

Plat rectangulaire,
2 empreintes
Platte rechteckig,
2 Ringe
Fuente rectangular,
2 estanques
Vassoio rettangolare,
2 inserti

BUGR35 35 x 30 x 6 cm - 430 cl
13.70 x 11.95 x 2.40" - 145.40 oz



Pieces per box
Pièces par boîte
Stück pro Karton
Piezas por caja
Pezzi per scatola

BUFFET GASTRONORM

1/1

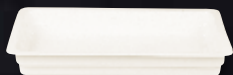

Gastronorm pan
Plat Gastronorm
Schale Gastronorm
Fuente Gastronorm
Contentitore Gastronorm

BUGN1.1 53 x 32.5 x 6.5 cm - 730 cl
20.85 x 12.80 x 2.55" -
246.85 oz



1/3

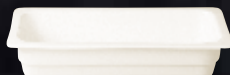

Gastronorm pan
Plat Gastronorm
Schale Gastronorm
Fuente Gastronorm
Contentitore Gastronorm

BUGN1.3 32.5 x 17.6 x 6.5 cm - 200 cl
12.80 x 6.95 x 2.55" - 67.65 oz

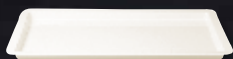

Gastronorm pan
Plat Gastronorm
Schale Gastronorm
Fuente Gastronorm
Contentitore Gastronorm

BUGN1.1F 53 x 32.5 x 2 cm - 220 cl
20.85 x 12.80 x 0.80" -
74.40 oz

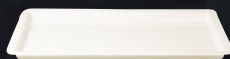

Gastronorm pan
Plat Gastronorm
Schale Gastronorm
Fuente Gastronorm
Contentitore Gastronorm

BUGN1.3F 32.5 x 17.6 x 2 cm - 79 cl
12.80 x 6.95 x 0.80" - 26.70 oz



1/2



Gastronorm pan
Plat Gastronorm
Schale Gastronorm
Fuente Gastronorm
Contentitore Gastronorm

BUGN1.2 32.5 x 26.5 x 6.5 cm - 330 cl
12.80 x 10.45 x 2.55" -
111.60 oz



2/3



Gastronorm pan
Plat Gastronorm
Schale Gastronorm
Fuente Gastronorm
Contentitore Gastronorm

BUGN2.3 32.5 x 35.4 x 6.5 cm - 478 cl
12.80 x 13.95 x 2.55" - 161.65 oz

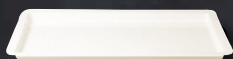

Gastronorm pan
Plat Gastronorm
Schale Gastronorm
Fuente Gastronorm
Contentitore Gastronorm

BUGN1.2F 32.5 x 26.5 x 2 cm - 130 cl
12.80 x 10.45 x 0.80" -
43.95 oz



Gastronorm pan
Plat Gastronorm
Schale Gastronorm
Fuente Gastronorm
Contentitore Gastronorm

BUGN2.3F 32.5 x 35.4 x 2 cm - 188 cl
12.80 x 13.95 x 0.80" - 63.65 oz



 Pieces per box
Pièces par boîte
Stück pro Karton
Piezas por caja
Pezzi per scatola

2/4

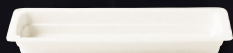

Gastronorm pan
Plat Gastronorm
Schale Gastronorm
Fuente Gastronorm
Contentitore Gastronorm

BUGN2.4 53 x 16.2 x 6.5 cm - 260 cl
20.85 x 6.40 x 2.55" - 87.90 oz



Round gastronorm pan
Plat Gastronorm rond
Schale Gastronorm rund
Fuente Gastronorm
redondo
Contentitore Gastronorm
rotondo

BUGN39 39 x 6.2 cm - 433 cl
15.35 x 2.45" - 146.40 oz

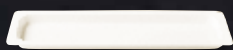

Gastronorm pan
Plat Gastronorm
Schale Gastronorm
Fuente Gastronorm
Contentitore Gastronorm

BUGN2.4F 53 x 16.2 x 2 cm - 125 cl
20.85 x 6.40 x 0.80" - 42.25 oz



**Round divided
Gastronorm pan**
Plat Gastronorm
rond divisé
Schale Gastronorm
rund geteilt
Fuente Gastronorm
redondo dividido
Contentitore Gastronorm
rotondo con divisione

BUGN39D 39 x 6.2 cm - 400 cl
15.35 x 2.45" - 135.25 oz



Half-moon gastronorm pan
Plat Gastronorm demi-lune
Schale Gastronorm Halbmond
Fuente Gastronorm media-luna
Contentitore Gastronorm mezzaluna

BUGN20 39 x 19.5 x 6.5 cm - 191 cl
15.35 x 7.70 x 2.55" - 64.60 oz



Half-moon gastronorm pan
Plat Gastronorm demi-lune
Schale Gastronorm Halbmond
Fuente Gastronorm media-luna
Contentitore Gastronorm mezzaluna

BUGN20F 39 x 19.5 x 2 cm - 95 cl
15.35 x 7.70 x 0.80" - 32.10 oz



CHOICE **NEW**

En

Its delicate rim design blends into contemporary settings.

Fr

Son délicat dessin sur l'alle se fond dans les ambiances contemporaines.

De

Das zarte Muster entlang der Ränder fügt sich harmonisch in ein modernes Ambiente ein.

Es

Su delicado diseño en el ala del plato armoniza con los ambientes contemporáneos.

It

Il suo delicato disegno sull'ala si fonde con le atmosfere contemporanee.





CHOICE **NEW**



Round flat plate

Assiette plate ronde
Teller flach rund
Plato llano redondo
Piatto piano rotondo

CLFP33D180 33 cm / 13"
CLFP31D180 31 cm / 12.20"



CLFP29D180 29 cm / 11.40"
CLFP28D180 28 cm / 11"
CLFP27D180 27 cm / 10.65"
CLFP24D180 24 cm / 9.45"



CLFP21D180 21 cm / 8.25"
CLFP19D180 19 cm / 7.50"
CLFP17D180 17 cm / 6.70"
CLFP15D180 15 cm / 5.90"



Non stackable cup

Tasse non empilable
Tasse nicht stapelbar
Taza no apilable
Tazza non impilabile

CLCU28D180 28 cl / 9.45 oz
CLCU23D180 23 cl / 7.80 oz
CLCU20D180 20 cl / 6.75 oz
CLCU09D180 9 cl / 3.05 oz



Stackable cup

Tasse empilable
Tasse stapelbar
Taza apilable
Tazza impilabile

CLSC23D180 23 cl / 7.80 oz
CLSC20D180 20 cl / 6.75 oz
CLSC09D180 9 cl / 3.05 oz



Round deep plate

Assiette creuse ronde
Teller tief rund
Plato hondo redondo
Piatto fondo rotondo

CLDP30D180 30 cm / 11.80"



CLDP26D180 26 cm / 10.25"
CLDP24D180 24 cm / 9.45"
CLDP19D180 19 cm / 7.55"



Saucer for cup

Soucoupe pour tasse
Untere für Tasse
Platillo para taza
Piattino per tazza

CLSA17D180 > **CLCU28D180**
17 cm / 6.70"

CLSA15D180 > **CLCU23D180** / **CLSC23D180** /
CLCU20D180 / **CLSC20D180**

15 cm / 5.90"

CLSA13D180 > **CLCU09D180** / **CLSC09D180**
13 cm / 5.10"



Extra deep round plate

Assiette extra creuse ronde
Teller extra tief rund
Plato extra hondo redondo
Piatto extra fondo rotondo

CLXD26D180 26 cm - 48 cl
10.25" - 16.25 oz

CLXD23D180 23 cm - 32 cl
9.05" - 10.80 oz



 Pieces per box
Pièces par boîte
Stück pro Karton
Piezas por caja
Pezzi per scatola

You will find a wide range of perfectly compatible accessories among the Classic Gourmet, Banquet and Nano series in the IVORIS catalogue
Vous pouvez trouver une vaste gamme d'accessoires parfaitement compatibles dans les séries Classic Gourmet, Banquet et Nano du catalogue IVORIS.
Die Serien Classic Gourmet, Banquet und Nano im Katalog IVORIS umfassen eine große Auswahl an rundum kompatiblen Accessoires.
Podrá encontrar una amplia gama de accesorios totalmente compatibles en las series Classic Gourmet, Banquet y Nano del catálogo IVORIS.
Le serie Classic Gourmet, Banquet e Nano del catalogo IVORIS offrono una vasta gamma di accessori perfettamente compatibili.



CLASSIC GOURMET

En

With its range of square, round or rectangular shapes, CLASSIC GOURMET's easy handling and extreme toughness are a must for any professional.

Fr

Grâce à l'éventail de ses formes carrées, rondes ou rectangulaires, CLASSIC GOURMET offre une facilité de manipulation et une résistance extrême qui séduit les professionnels.

De

Dank des großen Spektrums an quadratischen, runden und rechteckigen Formen bietet die Serie CLASSIC GOURMET eine einfache Handhabung und eine extreme Langlebigkeit, die alle Profis aus der Gastronomie überzeugt.

Es

Gracias a la amplia variedad de sus formas cuadradas, redondas o rectangulares, CLASSIC GOURMET ofrece una facilidad de manipulación y una resistencia extrema que seduce a los profesionales.

It

Grazie alla sua vasta gamma di forme quadrate, rotonde e rettangolari, la facilità di utilizzo e la resistenza estrema, la linea CLASSIC GOURMET sa sedurre i professionisti.





CLASSIC GOURMET



Rectangular flat plate
Assiette plate rectangulaire
Teller flach rechteckig
Plato llano rectangular
Piatto piano rettangolare

CLRP38 38 x 21 cm
14.95 x 8.25"

CLRP33 33 x 23 cm
13 x 9.05"



CLRP29 29 x 12 cm
11.40 x 4.70"

CLRP26 26 x 8 cm
10.25 x 3.15"

CLRP23 23 x 7 cm
9.05 x 2.75"

CLRP21 21 x 7 cm
8.25 x 2.75"



Square flat plate
Assiette plate carrée
Teller flach quadratisch
Plato llano cuadrado
Piatto piano quadrato

CLSP30 30 cm / 11.80"



CLSP27 27 cm / 10.65"

CLSP24 24 cm / 9.45"

CLSP17 17 cm / 6.70"



Round flat plate
Assiette plate ronde
Teller flach rund
Plato llano redondo
Piatto piano rotondo

CLFP33 33 cm / 13"

CLFP31 31 cm / 12.20"



CLFP29 29 cm / 11.40"

CLFP28 28 cm / 11"

CLFP27 27 cm / 10.65"

CLFP24 24 cm / 9.45"



CLFP21 21 cm / 8.25"

CLFP19 19 cm / 7.50"

CLFP17 17 cm / 6.70"

CLFP15 15 cm / 5.90"

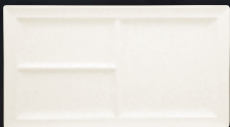

Rectangular tray, 3 compartments
Plat rectangulaire,
3 compartiments
Platte rechteckig,
3 Flächen
Bandeja rectangular,
3 compartimentos
Vassoio rettangolare,
3 compartimenti

CLRP38IN3 39 x 21 cm
15.30 x 8.40"

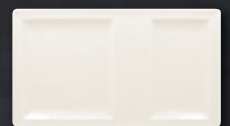

Rectangular tray, 2 compartments
Plat rectangulaire,
2 compartiments
Platte rechteckig,
2 Flächen
Bandeja rectangular,
2 compartimentos
Vassoio rettangolare,
2 compartimenti

CLRP37IN2 37 x 21 cm
14.55 x 8.25"



Round deep plate
Assiette creuse ronde
Teller tief rund
Plato hondo redondo
Piatto fondo rotondo

CLDP30 30 cm / 11.80"



CLDP28 28 cm / 11"

CLDP26 26 cm / 10.25"

CLDP24 24 cm / 9.45"

CLDP19 19 cm / 7.55"



Extra deep round plate
Assiette extra creuse ronde
Teller extra tief rund
Plato extra hondo redondo
Piatto extra fondo rotondo

CLXD26 26 cm - 48 cl
10.25" - 16.25 oz

CLXD23 23 cm - 32 cl
9.05" - 10.80 oz



**Square salad bowl**

Saladier carré
Salatschale quadratisch
Ensaladera cuadrada
Insalatiera quadrata

CLSB21 21 cm - 4.5 cm - 65 dl
8.25" - 1.75" - 22 oz



CLSB18 18 cm - 4.5 cm - 45 dl
7.10" - 1.75" - 15.20 oz

CLSB16 16 cm - 4.5 cm - 40 dl
6.30" - 1.75" - 13.55 oz

CLSB14 14 cm - 4.5 cm - 32 dl
5.50" - 1.75" - 10.80 oz

CLSB12 12 cm - 4.5 cm - 20 dl
4.70" - 1.75" - 6.75 oz

**Cream soup bowl with 2 handles**

Tasse bouillon avec 2 anses
Suppentasse mit 2 Henkel
Bol consommé con 2 asas
Scodella per zuppa con 2 manici

CLCS30 10.5 cm - 6 cm - 30 dl
4.15" - 2.35" - 10.15 oz

**Non stackable cup**

Tasse non empilable
Tasse nicht stapelbar
Taza no apilable
Tazza non impilabile

CLCU28 28 cl / 9.45 oz

CLCU23 23 cl / 7.80 oz

CLCU20 20 cl / 6.75 oz

CLCU09 9 cl / 3.05 oz

**Stackable cup**

Tasse empilable
Tasse stapelbar
Taza apilable
Tazza impilabile

CLSC23 23 cl / 7.80 oz

CLSC20 20 cl / 6.75 oz

CLSC09 9 cl / 3.05 oz

**Saucer for cup**

Soucoupe pour tasse
Untere für Tasse
Platillo para taza
Piattino per tazza

CLSA17 > CLCU28 / CLCS30

17 cm / 6.70"

CLSA15 > CLSC(CU)23 /

CLSC(CU)20

15 cm / 5.90"

CLSA13 > CLSC09 / CLCU09

13 cm / 5.10"

**Coffee pot & lid**

Cafetière & couvercle
Kaffeekanne & Deckel
Cafetera & tapa
Caffettiera & coperchio

CLCP35 35 dl / 11.85 oz

**Lid for coffee pot**

Couvercle pour cafetière
Deckel für Kaffeekanne
Tapa para cafetera

CLCPLD1

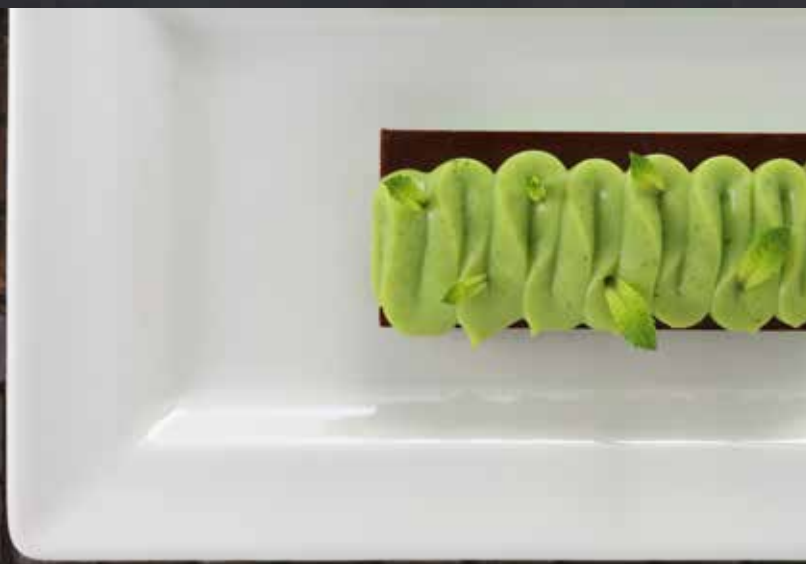

CLASSIC GOURMET



Teapot & lid

Théière & couvercle
Teekanne & Deckel
Tetera & tapa
Teiera & coperchio

CLTP40 40 cl / 13.55 oz



Salt shaker

Salière
Salzstreuer
Salero
Saliera

CLSS01



Lid for teapot

Couvercle pour théière
Deckel für Teekanne
Tapa para tetera
Coperchio per teiera

CLTP40LD



Pepper shaker

Poivrier
Pfefferstreuer
Pimentero
Pepiera

CLPS01



Creamer

Crémier
Milchkännchen
Lechera
Bricco da latte

CLCR25 25 cl / 8.45 oz

CLCR15 15 cl / 5.05 oz



Egg cup

Coquetier
Eierbecher
Huevera
Portauovo

CLEG01



Sugar bowl & lid

Sucrier & couvercle
Zuckerdose & Deckel
Azucarero & tapa
Zuccheriera & coperchio

CLSU27 27 cl / 9.15 oz



Lid for sugar bowl

Couvercle pour sucrier
Deckel für Zuckerdose
Tapa para azucarero
Coperchio per zuccheriera

CLSULD



Pieces per box
Pièces par boîte
Stück pro Karton
Piezas por caja
Pezzi per scatola



FAVOURITE **NEW**

En

This relief decoration creates a dynamic and modern character.

Fr

De cette décoration en relief se dégage un caractère dynamique et moderne.

De

Ein erhabenes Dekor, das einen dynamischen, modernen Charakter ausstrahlt.

Es

Su decoración en relieve desprende un carácter dinámico y moderno.

It

Da questa decorazione in rilievo emerge un carattere dinamico e moderno.

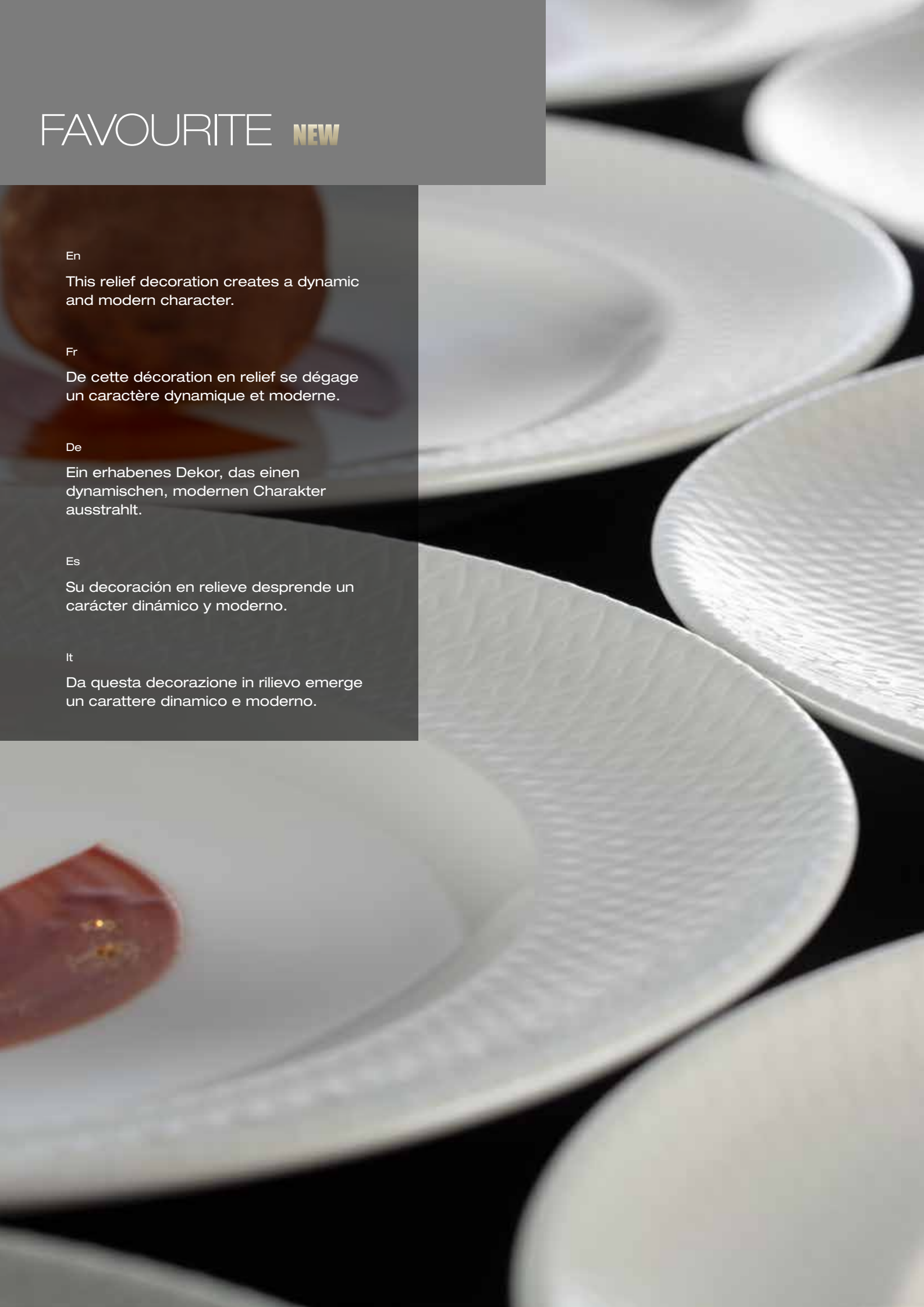



FAVOURITE **NEW**



Round flat plate

Assiette plate ronde
Teller flach rund
Plato llano redondo
Piatto piano rotondo

CLFP31D185 31 cm / 12.20"



CLFP29D185 29 cm / 11.40"

CLFP28D185 28 cm / 11"

CLFP27D185 27 cm / 10.65"

CLFP24D185 24 cm / 9.45"



CLFP21D185 21 cm / 8.25"

CLFP19D185 19 cm / 7.50"

CLFP17D185 17 cm / 6.70"

CLFP15D185 15 cm / 5.90"



Non stackable cup

Tasse non empilable
Tasse nicht stapelbar
Taza no apilable
Tazza non impilabile

CLCU28D185 28 cl / 9.45 oz

CLCU23D185 23 cl / 7.80 oz

CLCU20D185 20 cl / 6.75 oz

CLCU09D185 9 cl / 3.05 oz



Stackable cup

Tasse empilable
Tasse stapelbar
Taza apilable
Tazza impilabile

CLSC23D185 23 cl / 7.80 oz

CLSC20D185 20 cl / 6.75 oz

CLSC09D185 9 cl / 3.05 oz



Round deep plate

Assiette creuse ronde
Teller tief rund
Plato hondo redondo
Piatto fondo rotondo

CLDP30D185 30 cm / 11.80"



CLDP26D185 26 cm / 10.25"

CLDP24D185 24 cm / 9.45"

CLDP19D185 19 cm / 7.55"



Saucer for cup

Soucoupe pour tasse
Untere für Tasse
Platillo para taza
Piattino per tazza

CLSA17D185 > **CLCU28D185**

17 cm / 6.70"

CLSA15D185 > **CLCU23D185** / **CLSC23D185** /
CLCU20D185 / **CLSC20D185**

15 cm / 5.90"

CLSA13D185 > **CLCU09D185** / **CLSC09D185**

13 cm / 5.10"



Extra deep round plate

Assiette extra creuse ronde
Teller extra tief rund
Plato extra hondo redondo
Piatto extra fondo rotondo

CLXD26D185 26 cm - 48 cl
10.25" - 16.25 oz

CLXD23D185 23 cm - 32 cl
9.05" - 10.80 oz



Pieces per box
Pièces par boîte
Stück pro Karton
Piezas por caja
Pezzi per scatola

You will find a wide range of perfectly compatible accessories among the Classic Gourmet, Banquet and Nano series in the IVORIS catalogue
Vous pouvez trouver une vaste gamme d'accessoires parfaitement compatibles dans les séries Classic Gourmet, Banquet et Nano du catalogue IVORIS.
Die Serien Classic Gourmet, Banquet und Nano im Katalog IVORIS umfassen eine große Auswahl an rundum kompatiblen Accessoires.
Podrá encontrar una amplia gama de accesorios totalmente compatibles en las series Classic Gourmet, Banquet y Nano del catálogo IVORIS.
Le serie Classic Gourmet, Banquet e Nano del catalogo IVORIS offrono una vasta gamma di accessori perfettamente compatibili.



FINE DINE

En

FINE DINE's ultra-sleek line gives it a timeless elegance. Chefs love the vast array of items which make up this series for desserts, breakfasts and starters.

Fr

Les lignes très épurées de FINE DINE lui confèrent une élégance intemporelle. Les chefs apprécient la multitude de pièces formant la série pour les desserts, petits-déjeuners et entrées.

De

Die schlichten Linien verleihen der Serie FINE DINE eine zeitlose Eleganz. Die Küchenchefs schätzen die Vielzahl an Teilen der Serie für Desserts, Frühstück und Vorspeisen.

Es

Las líneas depuradas de FINE DINE le confieren una elegancia atemporal. Los chefs aprecian la multitud de piezas que forman la serie para postres, desayunos y entrantes.

It

La collezione FINE DINE presenta delle linee essenziali che le conferiscono un'eleganza senza tempo. Gli chef apprezzano la miriade di pezzi che formano la serie per i dessert, le colazioni e gli antipasti.





FINE DINE



Flat plate

Assiette plate
Teller flach
Plato llano
Piatto piano

FDFP33 33 cm / 13"

FDFP31 31 cm / 12.20"



FDFP29 29 cm / 11.40"

FDFP27 27 cm / 10.65"

FDFP25 25 cm / 9.85"

FDFP22 22 cm / 8.65"



FDFP16 16 cm / 6.30"



Cover for gourmet deep plate

Cloche pour assiette creuse gourmet
Cloche für Gourmetteller tief
Campana para plato hondo gourmet
Coperchio per piatto piano gourmet

FDCL02 > FDGD29

15.5 cm / 6.10"

FDCL01 > FDGD26

13.6 cm / 5.35"



Oval platter

Plat ovale
Platte oval
Fuente oval
Piatto ovale

FDOP30 30 x 8 cm

11.80 x 3.15"



Deep plate

Assiette creuse
Teller tief
Plato hondo
Piatto fondo

FDDP31 31 cm / 12.20"



FDDP23 23 cm / 9.05"



Oval platter

Plat ovale
Platte oval
Fuente oval
Piatto ovale

FDOP46 46 x 22 cm

18.10 x 8.65"

FDOP40 40 x 19 cm

15.75 x 7.50"



NEW

Deep coupe plate

Assiette creuse coupe
Teller tief coup
Plato hondo coupe
Piatto fondo senza falda

FDDC27 26.5 cm / 10.45"



Gourmet flat plate

Assiette plate gourmet
Gourmetteller flach
Plato llano gourmet
Piatto piano gourmet

FDGF33 33 cm / 13"



FDGF29 29 cm / 11.40"



Oval platter

Plat ovale
Platte oval
Fuente oval
Piatto ovale

FDOP36 36 x 27 cm

14.15 x 10.65"

FDOP34 34 x 25.5 cm

13.40 x 10.05"



FDOP26 26 x 20 cm

10.25 x 7.85"

FDOP22 22 x 17 cm

8.65 x 6.70"

FDOP17 17 x 12.8 cm

6.70 x 5.05"



Gourmet deep plate

Assiette creuse gourmet
Gourmetteller tief
Plato hondo gourmet
Piatto fondo gourmet

FDGD29 29 cm / 11.40"

FDGD26 26 cm / 10.25"



**Oval salad bowl**

Saladier ovale
Salatschale oval
Ensaladera oval
Insalatiera ovale

FDBO27 27 x 19 cm - 6 cm
10.65 x 7.50" - 2.35"

FDBO24 24 x 16 cm - 8 cm
9.45 x 6.30" - 3.15"

FDBO16 16 x 11 cm - 5 cm
6.30 x 4.35" - 1.95"

**Round salad bowl**

Saladier rond
Salatschale rund
Ensaladera redonda
Insalatiera rotonda

FDBS23 23 cm - 8.2 cm - 140 cl
9.05" - 3.25" - 47.35 oz

**Round bowl**

Bol rond
Schale rund
Bol redondo
Coppetta rotonda

FDBI18 18 cm - 9 cm - 100 cl
7.10" - 3.55" - 33.80 oz



FDBI14 14 cm - 6.5 cm - 45 cl
5.50" - 2.65" - 15.20 oz

FDBI12 12 cm - 6 cm - 28 cl
4.70" - 2.35" - 9.45 oz

FDBI11 11 cm - 5 cm - 22 cl
4.35" - 1.95" - 7.45 oz

FDBI08 8 cm - 4 cm - 11 cl
3.15" - 1.55" - 3.70 oz

**Lid for bowl**

Couvercle pour bol
Deckel für Schale
Tapa para bol
Coperchio per coppetta

FDBI14LD > FDBI14 14.2 cm - 4.5 cm
5.60" - 1.75"

FDBI11LD > FDBI11 11.6 cm - 3.6 cm
4.55" - 1.40"

**Extra thick round bowl**

Bol rond extra épais
Schale rund extra dick
Bol redondo extra grueso
Coppetta rotonda alto spessore

FDBI14M 14 cm - 6.5 cm - 45 cl
5.50" - 2.65" - 15.20 oz

**Cream soup bowl with 2 handles**

Tasse à bouillon avec 2 anses
Suppentasse mit 2 Henkel
Bol consommé con 2 asas
Scodella per zuppa con 2 manici

FDCS35 11 cm - 6 cm - 35 cl
4.35" - 2.35" - 11.85 oz

**Cream soup bowl without handle**

Tasse à bouillon sans anse
Suppentasse ohne Henkel
Bol consommé sin asa
Scodella per zuppa senza manici

FDCS01 11 cm - 6 cm - 35 cl
4.35" - 2.35" - 11.85 oz

**Saucer for cream soup bowl**

Soucoupe pour tasse à bouillon
Untere für Suppentasse
Platillo para bol consommé
Piattino per scodella per zuppa

FDSA19 > FDSC35 / FDSC01
19 cm / 7.50"



FINE DINE



Breakfast cup

Tasse à déjeuner
Frühstückstasse
Taza de desayuno
Tazza da colazione

FDCU30 30 cl / 10.15 oz

12



Saucer for espresso cup

Soucoupe pour tasse à expresso
Untere für Espressotasse
Platillo para taza a expreso
Piattino per tazza da espresso

FDSA13 > FDCU09 13 cm / 5.10"

12



Saucer for breakfast cup

Soucoupe pour tasse à déjeuner
Untere für Frühstückstasse
Platillo para taza de desayuno
Piattino per tazza da colazione

FDSA17 > FDCU30 17 cm / 6.70"

12



Square saucer for espresso cup

Soucoupe carrée pour tasse à expresso
Untere quadratisch für Espressotasse
Platillo cuadrado para taza expreso
Piattino quadrato per Tazza da espresso

OPSA12 > FDCU09 13 cm / 5.10"

12



Tea/coffee cup

Tasse à thé/café
Tee- /Kaffeetasse
Taza a té/café
Tazza da tè/caffè

FDCU25 25 cl / 8.45 oz

FDCU20 20 cl / 6.75 oz

12



Mug

Chope
Becher
Mug
Mug

FDMU30 30 cl / 10.15 oz

12



Saucer for tea/coffee cup

Soucoupe pour tasse à thé/café
Untere für Tee- /Kaffeetasse
Platillo para taza a té/café
Piattino per tazza da tè/caffè

FDSA15 > FDCU25 / FDCU20

15 cm / 5.90"

12



Breakfast cup without handle

Tasse à déjeuner sans anse
Frühstückstasse ohne Henkel
Taza de desayuno sin asa
Tazza da colazione senza manici

FDCU30M1 30 cl / 10.15 oz

12



Saucer for breakfast cup

Soucoupe pour tasse à déjeuner
Untere für Frühstückstasse
Platillo para taza de desayuno
Piattino per tazza da colazione

FDSA17 > FDMU30 / FDCU30M1 17 cm / 6.70"

12



Espresso Cup

Tasse à expresso
Espressotasse
Taza a expreso
Tazza da espresso

FDCU09 9 cl / 3.05 oz

12



Square saucer for breakfast cup

Soucoupe carrée pour tasse à déjeuner
Untere quadratisch für Frühstückstasse
Platillo cuadrado para taza de desayuno
Piattino quadrato per tazza da colazione

OPSA14 > FDMU30 / FDCU30M1 / FDCU30

14 cm / 5.50"

12

**Coffee pot & lid**

Cafetière & couvercle
Kaffeekanne & Deckel
Cafetera & tapa
Caffettiera & coperchio

FDCP70 70 cl / 23.65 oz

FDCP35 35 cl / 11.85 oz

**Lid for coffee pot**

Couvercle pour cafetière
Deckel für Kaffeekanne
Tapa para cafetera
Coperchio per caffettiera

FDCPLD2 > **FDCP70**

FDCPLD1 > **FDCP35**

**Teapot & lid**

Théière & couvercle
Teekanne & Deckel
Tetera & tapa
Teiera & coperchio

FDTP80 80 cl / 27.05 oz

FDTP40 40 cl / 13.55 oz

**Lid for teapot**

Couvercle pour théière
Deckel für Teekanne
Tapa para tetera
Coperchio per teiera

FDTPLD2 > **FDTP80**

FDTPLD1 > **FDTP40**

**Creamer**

Crémier
Milchkännchen
Lechera
Bricco da latte

FDCR40 40 cl / 13.55 oz

FDCR25 25 cl / 8.45 oz

FDCR15 15 cl / 5.05 oz



FDCR05 5 cl / 1.70 oz

**Sugar bowl & lid**

Sucrier & couvercle
Zuckerdose & Deckel
Azucarero & tapa
Zuccheriera & coperchio

FDSU22 22 cl / 7.45 oz

**Lid for sugar bowl**

Couvercle pour sucrier
Deckel für Zuckerdose
Tapa para azucarero
Coperchio per zuccheriera

FDSULD

**Pepper shaker**

Poivrier
Pfefferstreuer
Pimentero
Pepiera

FDPS01

**Salt shaker**

Salière
Salzstreuer
Salero
Saliera

FDSS01



Pieces per box
Pièces par boîte
Stück pro Karton
Piezas por caja
Pezzi per scatola

GIRO

En

Designed by Gemma Bernal, the hospital series plays with the rules and takes its inspiration from the oval shape together with an off-centre design.

GIRO is made up of oval, round, flat and deep plates, bowls and salad dishes and plates in different sizes, inviting you to perfect your settings mirroring the original outline.

Fr

Dessinée par Gemma Bernal, la série GIRO se joue des règles et prend naissance dans la forme ovale associée à une composition décentrée. Composée d'assiettes ovales, rondes, plates ou creuses, de bols, de saladiers et de plats de dimensions diverses, GIRO invite à sublimer les mises en scène en épousant ses contours originaux.

De

Die von Gemma Bernal entworfene Serie GIRO spielt mit den Regeln und hat ihren Ursprung in der ovalen Form in Verbindung mit einer exzentrischen Komposition. GIRO besteht aus ovalen, runden, flachen oder tiefen Tellern, Schalen, Salatschalen und Platten verschiedener Größen und lädt dazu ein, die Inszenierung besonders in den Vordergrund zu rücken, indem sie den originellen Konturen angepasst wird.

Es

Diseñada por Gemma Bernal, la serie GIRO se burla de las normas y nace de la forma ovalada asociada a una composición descentrada.

GIRO, compuesta de platos ovalados y redondos, tanto llanos como hondos, tazones, ensaladeras y fuentes de diversas dimensiones, invita a sublimar las puestas en escena abrazando sus contornos originales.

It

Progettata da Gemma Bernal, la serie GIRO si prende gioco delle regole e prende vita nella forma ovale associata a una composizione decentrata.

Composta da piatti ovali, tondi, piani o fondi, ciotole, insalatiere e piatti di varie misure, GIRO invita a sublimare le presentazioni sposando i suoi contorni originali.

DESIGN BY GEMMA BERNAL





GIRO



Oval plate

Assiette ovale
Teller oval
Plato oval
Piatto ovale

GIOP39 38.7 x 31 cm
15.25 x 12.20"

GIOP36 36.2 x 29 cm
14.25 x 11.40"



GIOP34 33.7 x 27 cm
13.25 x 10.65"

GIOP30 30 x 24 cm
11.80 x 9.45"

GIOP25 25 x 20 cm
9.85 x 7.85"

GIOP17 17 x 14 cm
6.70 x 5.50"



Oval Platter

Plat ovale
Platte oval
Fuente oval
Piatto ovale

GIPL34 34 x 22 cm
13.40 x 8.65"

GIPL30 30 x 18 cm
11.80 x 7.10"

GIPL25 25 x 13 cm
9.85 x 5.10"



Round plate

Assiette ronde
Teller rund
Plato redondo
Piatto rotondo

GIFP30 30 cm / 11.80"



GIFP27 27 cm / 10.65"



GIFP21 21 cm / 8.25"

GIFP18 18 cm / 7.10"

GIFP15 15 cm / 5.90"

GIFP10 10 cm / 3.95"



Oval deep plate

Assiette creuse ovale
Teller tief oval
Plato hondo oval
Piatto fondo ovale

GIOD29 29 x 23 cm
11.40 x 9.05"

GIOD24 24 x 19 cm
9.45 x 7.50"



Oval bowl

Bol ovale
Schale oval
Bol oval
Coppetta ovale

GIQB26 26 x 20.3 cm - 7.8 cm
10.25 x 8" - 3.05"

GIQB23 22.9 x 18 cm - 6.5 cm
9 x 7.10" - 2.55"

GIQB20 20.2 x 16 cm - 5.5 cm
7.95 x 6.30" - 2.15"



GIQB16 16.1 x 12 cm - 4.8 cm
6.35 x 4.70" - 1.90"



Round deep plate

Assiette creuse ronde
Teller tief rund
Plato hondo redondo
Piatto fondo rotondo

GIDP24 24 cm / 9.45"



**Breakfast cup**

Tasse à déjeuner
Frühstückstasse
Taza a desayuno
Tazza da colazione

GICU39 11.5 cm - 39 cl
4.55" - 13.20 oz

**Coffee cup**

Tasse à café
Kaffeetasse
Taza a café
Tazza da caffè

GICU20 8 cm - 20 cl
3.15" - 6.75 oz

GICU15 7.2 cm - 15 cl
2.85" - 5.05 oz

**Chocolate cup**

Tasse à chocolat
Schokotasse
Taza a chocolate
Tazza da cioccolata

GICU29 9.3 cm - 29 cl
3.65" - 9.80 oz

**Espresso cup**

Tasse à expresso
Espressotasse
Taza a expreso
Tazza da espresso

GICU09 6 cm - 9 cl
2.35" - 3.05 oz

**Coffee cup**

Tasse à café
Kaffeetasse
Taza a café
Tazza da caffè

GICU23 8.3 cm - 23 cl
3.25" - 7.80 oz

**Saucer**

Soucoupe
Untere
Platillo
Piattino

**GISA14 > GICU20 / GICU15 /
GICU09**

14.5 cm / 5.70"

**Saucer**

Soucoupe
Untere
Platillo
Piattino

GISA17 > GICU39 / GICU29 / GICU23
17 cm / 6.70"

**Oval saucer**

Soucoupe ovale
Untere oval
Platillo oval
Piattino ovale

**GISA29 > GICU29 / GICU23 /
GICU15 / GICU09**

29 x 16 cm / 11.40 x 6.30"





Coffee pot & lid

Cafetière & couvercle
Kaffekanne & Deckel
Cafetera & tapa
Caffettiera & copperchio

GICP35 35 cl / 11.85 oz



Jug / Creamer

Carafe / Crémier
Krug / Milchkännchen
Jarra / Lechera
Caraffa/bricco da latte

GIJU15 15 cl / 5.05 oz

GIJU09 9 cl / 3.05 oz



Lid for coffee pot

Couvercle pour cafetière
Deckel für Kaffekanne
Tapa para cafetera
Coperchio per caffettiera

GICP35LD



Sugar bowl & lid

Sucrier & couvercle
Zuckerdose & Deckel
Azucarero & tapa
Zuccheriera & copperchio

GISU01 8.5 cm - 7.8 cm

3.35" - 3.05"



Teapot & lid

Théière & couvercle
Teekanne & Deckel
Tetera & tapa
Teiera & copperchio

GITP40 40 cl / 13.55 oz



Lid for sugar bowl

Couvercle pour sucrier
Deckel für Zuckerdose
Tapa para azucarero
Coperchio per zuccheriera

GISU01LD



Lid for teapot

Couvercle pour théière
Deckel für Teekanne
Tapa para tetera
Coperchio per teiera

GITP40LD



Sugar pack holder

Sucrier sachets
Zuckertütenschale
Azucarero sobres
Portabustine da zucchero

GISH01 11.5 cm - 5 cm

4.55" - 1.95"



Jug

Carafe
Krug
Jarra
Caraffa

GIJU100 100 cl / 33.80 oz



GIJU50 50 cl / 16.90 oz



GIJU25 25 cl / 8.45 oz



Pieces per box
Pièces par boîte
Stück pro Karton
Piezas por caja
Pezzi per scatola



HOSPITAL & HEALTHCARE

En

Specially designed to meet the needs and constraints required by their users, these items fit perfectly within the standard meal transport and reheating systems that are already on the market.

Fr

Mis au point spécialement pour répondre aux exigences et contraintes requises par les utilisateurs, les pièces s'intègrent parfaitement dans les systèmes standards de transport de repas ou de remise en température présents sur le marché.

De

Speziell entwickelt für die Bedürfnisse und Anforderungen ihrer Benutzer, passen diese Artikel perfekt zu den standardisierten Speisentransport- und Wiedererwärmungssystemen, die bereits auf dem Markt vertreten sind.

Es

Concepita appositamente per rispondere alle esigenze e alle limitazioni dei pazienti. Questi pezzi si integrano perfettamente nei sistemi standard per trasportare o riportare a temperatura gli alimenti presenti sul mercato.

It

Especialmente diseñados en atención a las necesidades y las restricciones de los usuarios, estos artículos responden de manera ideal a los sistemas comúnmente empleados para el transporte de alimentos y para su recalentamiento actualmente existentes en el mercado.

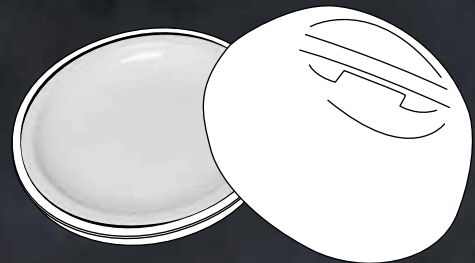

Unglazed flat bottom*
Fond plat non-émailé*
Boden unglasiert ohne Fuß*
Fondo plano sin esmaltar*
Fondo piatto smaltato*





**Healthcare flat plate
2 compartments**

Assiette plate patient
2 compartiments
Flacher Systemteller
2 Einteilungen
Plato llano paciente
2 compartimientos
Piatto piano paziente
2 compartimenti

SKHDP23 23 cm / 9"



Healthcare flat plate

Assiette plate patient
Flacher Systemteller
Plato llano paciente
Piatto piano paziente

SKHFP23 23 cm - 2.6 cm
9" - 1"



Healthcare flat plate with wide rim

Assiette plate patient aile large
Flacher Systemteller mit breitem Rand
Plato llano paciente con borde ancho
Piatto piano paziente con bordo largo

SKHFP23WR 23 cm - 2.2 cm
9" - 0.85"



**Healthcare flat plate
3 compartments**

Assiette plate patient
3 compartiments
Flacher Systemteller
3 Einteilungen
Plato llano paciente
3 compartimientos
Piatto piano paziente
3 compartimenti

ZADP24 24 cm - 2.6 cm
9.45" - 1"



ZADP21 21 cm - 2.6 cm
8.25" - 1"



Healthcare flat plate

Assiette plate patient
Flacher Systemteller
Plato llano paciente
Piatto piano paziente

ZARFP20 20 cm - 2.2 cm
7.85" - 0.85"



Straight round bowl

Bol rond droit
Schale rund gerade
Bol redondo recto
Coppetta rotonda dritta

ZABW50 13 cm - 5.5 cm - 50 cl
5.10" - 2.15" - 16.90 oz



Non stackable bowl

Bol non empilable
Schale nicht stapelbar
Bol no apilable
Coppetta non impilabile

ZABW44 15 cm - 5.5 cm - 44 cl
5.90" - 2.15" - 14.90 oz



Soup bowl with handle

Tasse bouillon, 2 anses
Suppentasse, 2 Henkel
Bol consommé, 2 asas
Scodella per zuppa,
2 manici

ZASB28 10 cm - 6 cm - 28 cl
3.95" - 2.30" - 9.45 oz



Salad bowl

Saladier
Salatschale
Ensaladera
Insalatiera

ZASB21 10 cm - 5 cm - 21 cl
3.95" - 1.90" - 7.10 oz



HOSPITAL & HEALTHCARE

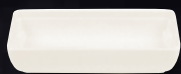

Rectangular bowl
Ravier rectangulaire
Schale rechteckig
Rabanera rectangular
Coppetta rettangolare

ZARB16 16 x 10 cm - 33 cl
6.30 x 3.95" - 11.15 oz



Rectangular dish
Ravier rectangulaire
Schale rechteckig
Rabanera rectangular
Coppetta rettangolare

SKRTD15 15 x 10 cm - 22 cl
5.90 x 3.95" - 7.45 oz



Rectangular bowl
Ravier rectangulaire
Schale rechteckig
Rabanera rectangular
Coppetta rettangolare

ZARB21 21 x 6 cm - 12 cl
8.25 x 2.35" - 4.05 oz



Bowl stackable
Bol empilable
Schale stapelbar
Bol apilable
Coppetta impilabile

SKBWL40 13 cm - 5.5 cm - 40 cl
5.10" - 2.20" - 13.55 oz



Sunshine mug
Chope Sunshine
Becher Sunshine
Mug Sunshine
Mug Sunshine

OPSMG24 24 cl / 8.10 oz



Cream bowl, 2 handles
Tasse à bouillon, 2 anses
Suppentasse, 2 Henkel
Bol consommé, 2 asas
Scodella per zuppa, 2 manici

PXCS35 11.5 cm - 6.5 cm - 35 cl
4.50" - 2.60" - 11.85 oz

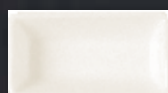

Rectangular dish
Ravier rectangulaire
Schale rechteckig
Platillo rectangular
Coppetta rettangolare

ACRD10 10 x 5.8 cm - 8 cl
3.95 x 2.30" - 2.70 oz



Bowl
Bol
Schale
Bol
Coppetta

BABW14 14 cm - 6 cm - 63 cl
5.50" - 2.35" - 21.30 oz

BABW12 12 cm - 6 cm - 48 cl
4.70" - 2.35" - 16.25 oz



BACS01 10 cm - 6 cm - 30 cl
3.95" - 2.30" - 10.15 oz



Square dish
Ravier carré
Schale quadratisch
Rabanera cuadrada
Coppetta quadrata

SKSTD11 11 cm - 21 cl
4.35" - 7.10 oz



Cream soup bowl, 2 handles
Tasse à bouillon, 2 anses
Suppentasse, 2 Henkel
Bol consommé, 2 asas
Scodella per zuppa, 2 manici

BACS30 10.5 cm - 5.5 cm - 30 cl
4.15" - 2.20" - 10.15 oz





Saucer
Soucoupe
Untertasse
Platillo
Piattino

BAST01 > **BACS30** / **BASB12** / **BACS01**
17 cm / 6.70"

12



Teapot & lid
Théière & couvercle
Teekanne & Deckel
Tetera & tapa
Teiera & coperchio

BATP40 40 cl / 13.55 oz

4



Stackable salad bowl
Saladier empilable
Salatschale stapelbar
Ensaladera apilable
Insalatiera impilabile

BASB16 16 cm - 7 cm - 60 cl
6.30" - 2.70" - 20.30 oz

BASB12 12 cm - 5.5 cm - 25 cl
4.70" - 2.15" - 8.45 oz

12



Stackable cup
Tasse empilable
Tasse stapelbar
Taza apilable
Tazza impilabile

BACU23 23 cl / 7.80 oz

12



Stackable mug
Chope empilable
Becher stapelbar
Mug apilable
Mug impilabile

BASM30 30 cl - 10.15 oz

12



Saucer
Soucoupe
Untertasse
Platillo
Piattino

BASA15 > **BACU23**

15 cm / 5.90"

12



Egg cup
Coquetier
Eierbecher
Huevera
Portauovo

BAEG01

6



Pieces per box
Pièces par boîte
Stück pro Karton
Piezas por caja
Pezzi per scatola

LACE **NEW**

En

The timeless quality and quaint charm of the decoration will appeal to a wide audience.

Fr

Ce décor séduira un large public par son côté intemporel et son charme légèrement suranné.

De

Dieses zeitlose Dekor mit leicht altmodischem Charme spricht ein breites Publikum an.

Es

Esta decoración seducirá a un amplio público gracias a su carácter intemporal y su encanto ligeramente anticuado.

It

Questa decorazione sedurrà un vasto pubblico grazie al suo look senza tempo e al suo fascino leggermente retrò.







Round flat plate

Assiette plate ronde
Teller flach rund
Plato llano redondo
Piatto piano rotondo

CLFP31D182 31 cm / 12.20"



CLFP29D182 29 cm / 11.40"

CLFP28D182 28 cm / 11"

CLFP27D182 27 cm / 10.65"

CLFP24D182 24 cm / 9.45"



CLFP21D182 21 cm / 8.25"

CLFP19D182 19 cm / 7.50"

CLFP17D182 17 cm / 6.70"

CLFP15D182 15 cm / 5.90"



Non stackable cup

Tasse non empilable
Tasse nicht stapelbar
Taza no apilable
Tazza non impilabile

CLCU28D182 28 cl / 9.45 oz

CLCU23D182 23 cl / 7.80 oz

CLCU20D182 20 cl / 6.75 oz

CLCU09D182 9 cl / 3.05 oz



Stackable cup

Tasse empilable
Tasse stapelbar
Taza apilable
Tazza impilabile

CLSC23D182 23 cl / 7.80 oz

CLSC20D182 20 cl / 6.75 oz

CLSC09D182 9 cl / 3.05 oz



Round deep plate

Assiette creuse ronde
Teller tief rund
Plato hondo redondo
Piatto fondo rotondo

CLDP30D182 30 cm / 11.80"



CLDP26D182 26 cm / 10.25"

CLDP24D182 24 cm / 9.45"

CLDP19D182 19 cm / 7.55"



Saucer for cup

Soucoupe pour tasse
Untere für Tasse
Platillo para taza
Piattino per tazza

CLSA17D182 > **CLCU28D182**

17 cm / 6.70"

CLSA15D182 > **CLCU23D182** / **CLSC23D182** /
CLCU20D182 / **CLSC20D182**

15 cm / 5.90"

CLSA13D182 > **CLCU09D182** / **CLSC09D182**

13 cm / 5.10"



Extra deep round plate

Assiette extra creuse ronde
Teller extra tief rund
Plato extra hondo redondo
Piatto extra fondo rotondo

CLXD26D182 26 cm - 48 cl
10.25" - 16.25 oz

CLXD23D182 23 cm - 32 cl
9.05" - 10.80 oz



Pieces per box
Pièces par boîte
Stück pro Karton
Piezas por caja
Pezzi per scatola

You will find a wide range of perfectly compatible accessories among the Classic Gourmet, Banquet and Nano series in the IVORIS catalogue
Vous pouvez trouver une vaste gamme d'accessoires parfaitement compatibles dans les séries Classic Gourmet, Banquet et Nano du catalogue IVORIS.
Die Serien Classic Gourmet, Banquet und Nano im Katalog IVORIS umfassen eine große Auswahl an rundum kompatiblen Accessoires.
Podrá encontrar una amplia gama de accesorios totalmente compatibles en las series Classic Gourmet, Banquet y Nano del catálogo IVORIS.
Le serie Classic Gourmet, Banquet e Nano del catalogo IVORIS offrono una vasta gamma di accessori perfettamente compatibili.



LEON

En

The relief decoration of LEON gives it incomparable originality, strength of character and splendour. The range marries geometric shapes and durability with modernity.

Fr

Le décor en relief de LEON lui confère une originalité, une force de caractère et un éclat incomparables. La gamme marie formes géométriques, modernité et robustesse.

De

Das Reliefdekor der Serie LEON vermittelt Originalität sowie gleichermaßen Kraft, Charakter und einen unvergleichlichen Glanz. Diese Serie vereint geometrische Formen, moderne Akzente und Robustheit.

Es

La decoración en relieve de LEON le confiere una originalidad, una fuerza de carácter y un brillo incomparables. La gama combina formas geométricas, modernidad y robustez.

It

La decorazione in rilievo conferisce alla linea LEON incomparabile originalità, forza di carattere e brillantezza. La serie sposa forme geometriche, modernità e robustezza.







Flat plate

Assiette plate
Teller flach
Plato llano
Piatto piano

BAFP31D1 31 cm / 12.20"

BAFP30D1 30 cm / 11.80"



BAFP29D1 29 cm / 11.40"

BAFP27D1 27 cm / 10.65"

BAFP25D1 25 cm / 9.85"

BAFP24D1 24 cm / 9.45"

BAFP23D1 23 cm / 9.05"



BAFP21D1 21 cm / 8.25"

BAFP20D1 20 cm / 7.85"

BAFP19D1 19 cm / 7.50"

BAFP17D1 17 cm / 6.70"

BAFP15D1 15 cm / 5.90"



Oval platter

Plat ovale
Platte oval
Fuente oval
Piatto ovale

BAOP38D1 38 x 26 cm / 14.95 x 10.25"

BAOP32D1 32 x 22 cm / 12.60 x 8.65"



BAOP22D1 22 x 15.5 cm / 8.65 x 6.10"



Bowl

Bol
Schale
Bol
Coppetta

BABW14D1 14 cm - 6 cm - 63 cl

5.50" - 2.35" - 21.30 oz



Deep plate

Assiette creuse
Teller tief
Plato hondo
Piatto fondo

BADP30D1 30 cm / 11.80"



BADP26D1 26 cm / 10.25"

BADP23D1 23 cm / 9.05"



Cream soup bowl, 2 handles

Tasse bouillon, 2 anses
Suppentasse, 2 Henkel
Bol consommé, 2 asas
Scodella per zuppa, 2 manici

BAC30D1 10.5 cm - 5.5 cm - 30 cl

4.15" - 2.20" - 10.15 oz



Steak plate

Assiette à steak
Steakteller
Plato steak
Piatto per bistecca

BAOP30D1 30 x 25.5 cm

11.80 x 10.05"



Saucer

Soucoupe
Untere
Platillo
Piattino

BAST01D1 > **BACS30D1**

17 cm / 6.70"





Salad bowl

Saladier
Salatschale
Ensaladera
Insalatiera

BASP25D1 25 cm - 11 cm - 200 cl
9.85" - 4.35" - 67.65 oz



BASP20D1 20 cm - 8 cm - 105 cl
7.85" - 3.15" - 35.50 oz

BASP16D1 16 cm - 7.5 cm - 67 cl
6.30" - 2.95" - 22.65 oz



Stackable salad bowl

Saladier empilable
Salatschale stapelbar
Ensaladera apilable
Insalatiera impilabile

BASB21D1 21 cm - 7.5 cm - 118 cl
8.25" - 2.95" - 39.90 oz

BASB16D1 16 cm - 7 cm - 60 cl
6.30" - 2.70" - 20.30 oz



Stackable cup high

Tasse empilable haute
Tasse stapelbar hoch
Taza apilable alta
Tazza impilabile alta

BACU20D1 20 cl / 6.75 oz

BACU09D1 9 cl / 3.05 oz



Stackable cup

Tasse empilable
Tasse stapelbar
Taza apilable
Tazza impilabile

BACU23D1 23 cl / 7.80 oz

BACU18D1 18 cl / 6.10 oz



Saucer

Soucoupe
Untere
Platillo
Piattino

BASA15D1 > **BACU23D1**

BACU20D1

BACU18D1

15 cm / 5.90"



Saucer

Soucoupe
Untere
Platillo
Piattino

BASA13D1 > **BACU09D1**

13 cm / 5.10"



LEON



Creamer

Crémier
Milchkännchen
Lechera
Bricco da latte

BACR25D1 25 cl / 8.45 oz



Egg cup

Coquetier
Eierbecher
Huevera
Portauovo

BAEG01D1

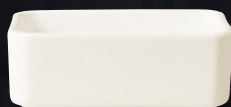

Sugar pack holder

Sucrier sachets
Zuckertütenschale
Azucarero sobres
Contentore per pacco di
zucchero

BASH01D1 11 x 7 cm - 4 cm
4.35 x 2.75" - 1.55"



Pepper shaker

Poivrier
Pfefferstreuer
Pimentero
Pepiera

BAPS01D1



Salt shaker

Salière
Salzstreuer
Salero
Saliera

BASS01D1



Sugar bowl & lid

Sucrier & couvercle
Zuckerdose & Deckel
Azucarero & tapa
Zuccheriera & coperchio

BASU27D1 27 cl / 9.15 oz



Lid for sugar bowl

Couvercle pour sucrier
Deckel für Zuckerdose
Tapa para azucarero
Coperchio per zuccheriera

BASULDD1



Pieces per box
Pièces par boîte
Stück pro Karton
Piezas por caja
Pezzi per scatola



LYRA

En

LYRA's natural elegance with its arched silhouette and graceful line make it possible to create harmonious and varied presentations.

Fr

L'élégance naturelle de LYRA avec sa silhouette galbée et sa ligne gracieuse permet des présentations harmonieuses et variées.

De

Die natürliche Eleganz der Serie LYRA mit der gerundeten Silhouette und der graziösen Linie ermöglichen ein harmonisches und abwechslungsreiches Anrichten.

Es

La elegancia natural de LYRA, con su silueta curvada y su atrayente línea, permite realizar presentaciones armoniosas y variadas.

It

L'eleganza naturale di LYRA con la sua silhouette curvilinea e le sue linee morbide assicura presentazioni armoniose e varie.

DESIGN BY MIKAELA DOERFEL





LYRA



Flat plate

Assiette plate
Teller flach
Plato llano
Piatto piano

LRFP31 31 cm / 12.20"



LRFP29 29 cm / 11.40"

LRFP27 27 cm / 10.65"

LRFP24 24 cm / 9.45"

LRFP21 21 cm / 8.25"



LRFP19 19 cm / 7.50"

LRFP17 17 cm / 6.70"

LRFP15 15 cm / 5.90"



Oval platter

Plat ovale
Platte oval
Fuente oval
Piatto ovale

LROP38 38 x 27 cm
14.95 x 10.65"

LROP32 32 x 22.5 cm
12.60 x 8.85"



LROP22 22 x 15.5 cm
8.65" x 6.10"



Deep plate

Assiette creuse
Teller tief
Plato hondo
Piatto fondo

LRDP30 30 cm / 11.80"



LRDP26 26 cm / 10.25"

LRDP23 23 cm / 9.05"



Stackable salad bowl

Saladier empilable
Salatschale stapelbar
Ensaladera apilable
Insalatiera impilabile

LRSB18 18 cm - 29 cl
7.10" - 9.80 oz

LRSB12 12 cm - 15 cl
4.70" - 5.05 oz



Non stackable soup bowl

Tasse à bouillon non empilable
Suppentasse nicht stapelbar
Bol consommé no apilable
Scodella per zuppa non impilabile

LRCN30 12 cm - 7.5 cm - 30 cl
4.70" - 2.95" - 10.15 oz



Tajine cover for deep plate

Couvercle tajine
pour assiette creuse
Tajine Deckel
für tiefe Teller
Tapa tajine
para plato hondo
Coperchio tajine
per piatto fondo

LRCV27 > LRDP30

LRCV23 > LRDP26

LRCV20 > LRDP23



Stackable soup bowl

Tasse à bouillon empilable
Suppentasse stapelbar
Bol consommé apilable
Scodella per zuppa impilabile

L RCS30 10.5 cm - 6 cm - 30 cl
4.15" - 2.35" - 10.15 oz



Saucer

Soucoupe
Untere
Platillo
Piattino

LRSA17 > LRCN30 / LRCS30
17 cm / 6.70"





Non stackable cup
Tasse non empilabile
Tasse nicht stapelbar
Taza no apilable
Tazza non impilabile

LRCU27 27 cl / 9.15 oz

LRCU22 22 cl / 7.45 oz

LRCU18 18 cl / 6.10 oz

12



Stackable cup
Tasse empilabile
Tasse stapelbar
Taza apilable
Tazza non impilabile

LRSC27 27 cl / 9.15 oz

LRSC22 22 cl / 7.45 oz

LRSC18 18 cl / 6.10 oz

12



Saucer
Soucoupe
Untere
Platillo
Piattino

LRSA17 > LRCU27 / LRSC27

17 cm / 6.70"

LRSA15 > LRCU22 / LRCU18 /
LRSC22 / LRSC18

15 cm / 5.90"

12



Non stackable cup
Tasse non empilabile
Tasse nicht stapelbar
Taza no apilable
Tazza non impilabile

LRSC09 9 cl / 3.05 oz

12



Stackable cup
Tasse empilabile
Tasse stapelbar
Taza apilable
Tazza non impilabile

LRSC09 9 cl / 3.05 oz

12



Saucer
Soucoupe
Untere
Platillo
Piattino

LRSA12 > LRCU09 / LRSC09

12 cm / 4.70"

12



LYRA



Sugar bowl & lid

Sucrier & couvercle
Zuckerdose & Deckel
Azucarero & tapa
Zuccheriera & coperchio

LRSU27 27 cl / 9.15 oz



Lid for sugar bowl

Couvercle pour sucrier
Deckel für Zuckerdose
Tapa para azucarero
Coperchio per zuccheriera

LRSULD



Teapot & lid

Théière & couvercle
Teekanne & Deckel
Tetera & tapa
Teiera & coperchio

LRTP40 40 cl / 13.50 oz



Lid for teapot

Couvercle pour théière
Deckel für Teekanne
Tapa para tetera
Coperchio per teiera

LRTPLD



Creamer

Crémier
Milchkännchen
Lechera
Bricco da latte

LRCR25 25 cl / 8.45 oz

LRCR15 15 cl / 5.05 oz



Egg cup

Coquetier
Eierbecher
Huevera
Portauovo

LREG01



Coffee pot & lid

Cafetière & couvercle
Kaffeekanne & Deckel
Cafetera & tapa
Caffettiera & coperchio

LRCP35 35 cl / 11.85 oz



Salt shaker

Salière
Salzstreuer
Salero
Saliera

LRSS01



Lid for coffee pot

Couvercle pour cafetière
Deckel für Kaffeekanne
Tapa para cafetera
Coperchio per caffettiera

LRCP35



Pepper shaker

Poivrier
Pfefferstreuer
Pimentero
Pepiera

LRPS01



Flower vase

Vase
Blumenvase
Florero
Vaso

LRFV01



 Pieces per box
Pièces par boîte
Stück pro Karton
Piezas por caja
Pezzi per scatola



MAREA



En

MAREA and its array of items is a collection of large tasting plates, a sharing plate and multifunctional dishes for a truly theatrical presentation.

Fr

MAREA et son florilège d'articles regroupe des assiettes de dégustation généreuses, un plat « à partager » et des assiettes à multiples facettes pour une théâtralité maximale.

De

MAREA und ihre Fülle an Teilen bietet großzügige Degustationsteller, eine Platte „zum Teilen“ und facettenreiche Teller für eine maximale Wirkung.

Es

MAREA y su florilegio de artículos agrupa platos de degustación generosos, una fuente “para compartir” y platos multifacetas para una teatralidad máxima.

It

MAREA e il suo florilegio di articoli raggruppa piatti da degustazione generosi, un piatto “da condividere” e piatti multiformi per la massima teatralità.

DESIGN BY GEMMA BERNAL



MAREA

ASTRO

Rectangular platter

Plat rectangulaire
Platte rechteckig
Fuente rectangular
Piatto rettangolare

MRRP35 35 x 25 cm
13.80 x 9.85"



MRRP25 25 x 20 cm
9.85 x 7.85"

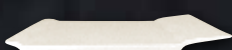
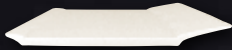

Square platter

Plat carré
Platte quadratisch
Fuente cuadrado
Piatto quadrato

MRSP25 25 cm / 9.85"



TOPTAPA

Plate

Assiette
Teller
Plato
Piatto

MRGP30 30 cm / 11.80"



Spoon

Cuillère
Löffel
Cuchara
Cucchiaio

MRSP01 12 x 5.2 cm
4.70 x 2.05"



CIRCUS

Round plate

Assiette ronde
Teller rund
Plato redondo
Piatto rotondo

MRFP30 30 cm / 11.80"

MRFP24 24 cm / 9.45"

MRFP18 18 cm / 7.10"



Oval plate

Assiette ovale
Teller oval
Plato oval
Piatto ovale

MROP18 18 x 11 cm
7.10 x 4.35"





SWITCH

Plate with indent
Assiette à encoche
Teller mit Fläche
Plato con estanque
Piatto con inserti

MRDP31 31 cm / 12.20"



MRDP27 27 cm / 10.65"



Goblet
Gobelet
Becher
Copa
Bicchiere

MRTB09 9 cl / 3.05 oz

MRTB07 7 cl / 2.35 oz



Salad bowl

Saladier
Salatschale
Ensaladera
Insalatiera

MRSB18 12.7 cm - 4 cm - 18 cl
5" - 1.55" - 6.10 oz



Bowl
Bol
Schale
Bol
Coppetta

MRBW30 12 cm - 6 cm - 30 cl
4.70" - 2.35" - 10.15 oz

MRBW13 10 cm - 4 cm - 13 cl
3.95" - 1.55" - 4.40 oz



 Pieces per box
Pièces par boîte
Stück pro Karton
Piezas por caja
Pezzi per scatola

MASSILIA

En

Thanks to designers Dominique and Alain Vavro, working together with the artistry of Marseille's Michelin-starred chef Gérald Passédat, MASSILIA combines a fresh design with impeccable symmetry to provide the perfect framework for the most exquisite gastronomic creations.

Fr

Grâce aux designers Dominique et Alain Vavro, alliés à l'œil créatif du chef étoilé marseillais Gérald Passédat, MASSILIA apporte une touche de fraîcheur d'une symétrie impeccable pour encadrer les réalisations gastronomiques les plus savantes.

De

Dank den Designern Dominique und Alain Vavro, zusammen mit dem professionellen Auge des besternten Küchenchefs Gérald Passédat, beinhaltet MASSILIA, in ihrer symmetrischen Formgebung die Anmutung der Frische, um eine Präsentationsbasis für feinste Kreationen zu sein.

Es

Gracias a los diseñadores Dominique y Alain Vavro, aliados del ojo creativo del chef marsellés Gérald Passédat, galardonado con dos estrellas, MASSILIA aporta un toque de frescura con una simetría impecable para enmarcar las más sabias realizaciones gastronómicas.

It

Grazie ai designer Dominique e Alain Vavro e all'occhio creativo dello chef stellato marsigliese Gérald Passédat, MASSILIA dona un tocco di freschezza e una simmetria impeccabile, per incorniciare le pietanze più prelibate.





MASSILIA



Square plate

Assiette carrée
Teller quadratisch
Plato cuadrado
Piatto quadrato

MSFP30 30 cm / 11.80"



MSFP27 27 cm / 10.60"

MSFP20 20 cm / 7.80"



Square bread plate

Assiette à pain carrée
Brotplatte quadratisch
Plato de pan cuadrado
Piatto da pane quadrato

MSFP14 14.5 cm / 5.70"

MSFP12 12 cm / 4.70"



Rectangular deep plate

Assiette creuse
rectangulaire
Teller tief rechteckig
Plato hondo rectangular
Piatto fondo rettangolare

MSDP27 27 x 21 cm - 55 cl
10.80 x 8.20" - 18.60 oz



Cloche for rectangular deep plate

Cloche pour assiette
creuse rectangulaire
Cloche für Teller tief
rechteckig
Campana para plato
hondo rectangular
Coperchio per piatto
fondo rettangolare

MSDP27LD > **MSDP27**



Coffee/tea cup

Tasse à café/thé
Kaffee-/Teetasse
Taza a café/té
Tazza da caffè/tè

MSCU17 8 cm - 17 cl
3.15" - 5.75 oz



Coffee/tea cup without handle

Tasse à café/thé sans anse
Kaffee-/Teetasse ohne Henkel
Taza a café/té sin asa
Tazza da caffè/tè senza manici

MSCU17M 8 cm - 17 cl
3.15" - 5.75 oz



Saucer for Coffee/tea cup

Soucoupe pour tasse à café/thé
Untere für Kaffee-/Teetasse
Platillo para taza a café/té
Piattino per tazza da caffè/tè

MSSA14 > **MSCU17** / **MSCU17M**
14.5 cm / 5.70"





Espresso cup
Tasse à expresso
Espressotasse
Taza a expreso
Tazza da espresso

MSCU10 6 cm - 11 cl
2.35" - 3.70 oz



Espresso cup without handle
Tasse à expresso sans anse
Espressotasse ohne Henkel
Taza a expreso sin asa
Tazza da espresso senza manici

MSCU10M 6 cm - 11 cl
2.35" - 3.70 oz



Saucer for Espresso cup
Soucoupe pour tasse à expresso
Untere für Espressotasse
Platillo para taza a expreso
Piattino per tazza da espresso

MSSA12 > MSCU10 / MSCU10M
12 cm / 4.70"



**Rectangular tray,
2 indents**
Plat rectangulaire,
2 empreintes
Platte rechteckig,
2 Ringe
Fuente rectangular,
2 estanques
Vassoio rettangolare,
2 inserti

MSRIN33 33 x 22 cm
13 x 8.65"

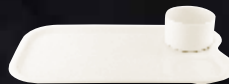

**Square tray,
2 indents**
Plat carré,
2 empreintes
Platte quadratisch,
2 Ringe
Fuente cuadrada,
2 estanques
Vassoio quadrato,
2 inserti

MSSIN22 20 cm / 7.85"



 Pieces per box
Pièces par boîte
Stück pro Karton
Piezas por caja
Pezzi per scatola

MAZZA

En

Bold and graceful, the MAZZA items are the perfect palette for your most avant-garde creations. Its novel and diverse shapes, inspired by the current fusion-food movement, offer endless variations for the most contemporary of presentations.

Fr

Audacieuse et svelte, la gamme MAZZA sert de cadre idéal à vos créations les plus avantgardistes. Ses formes inédites et variées, nées du courant fusion-food offrent diverses déclinaisons pour des mises en scène très contemporaines.

De

Die kühne und graziöse Serie MAZZA bildet den idealen Rahmen für avantgardistische Kreationen. Die neuen und abwechslungsreichen, von der aktuellen Fusion-Food-Welle inspirierten Formen bieten verschiedenste Möglichkeiten, Ihre Kompositionen auf zeitgenössische Weise in Szene zu setzen.

Es

La gama MAZZA, audaz y esbelta, sirve de marco ideal para sus creaciones más vanguardistas. Sus formas inéditas y variadas, nacidas de la corriente de cocina de fusión, ofrecen diversas declinaciones para crear puestas en escena muy contemporáneas.

It

Audace e scattante, la gamma MAZZA offre una cornice ideale alle vostre creazioni più all'avanguardia. Le sue forme inedite ed eterogenee, nate dalla corrente soprannominata "fusion", propongono varie declinazioni per presentazioni decisamente contemporanee.

DESIGN BY MIKAELA DOERFEL





MAZZA



Square flat plate

Assiette plate carrée
Teller flach quadratisch
Plato llano cuadrado
Piatto piano quadrato

MZSP32 32 x 29 cm
12.60 x 11.40"

MZSP26 26 x 23.5 cm
10.25 x 9.25"

MZSP20 20 x 18 cm
7.85 x 7.10"



Baguette tray

Plat baguette
Platte baguette
Bandeja baguette
Vassoio baguette

MZBP50 50 x 11 cm
19.70 x 4.35"

MZBP44 44 x 10.5 cm
17.30 x 4.15"

MZBP38 38 x 10 cm
14.95 x 4"

MZBP26 26 x 10 cm
10.25 x 3.95"



MZBP20 20 x 7.5 cm
7.85 x 2.95"



Rectangular flat plate

Assiette plate rectangulaire
Teller flach rechteckig
Plato llano rectangular
Piatto piano rettangolare

MZRP32 32 x 21 cm
12.60 x 8.25"

MZRP26 26 x 17 cm
10.25 x 6.70"

MZRP20 20 x 13 cm
7.85 x 5.10"



Twin plate

Plat twin
Platte twin
Plato doble twin
Piatto twin

MZTM53 53 x 17 cm
20.85 x 6.70"

MZTW53 53 x 30 cm
20.85 x 11.80"

MZTP42 42 x 11 cm
16.55 x 4.35"

MZTP32 32 x 10 cm
12.60 x 3.95"



Cocktail plate

Assiette cocktail
Cocktailteller
Plato cóctel
Piatto cocktail

MZCP32 32 x 9.5 cm
12.60 x 3.75"

MZCP26 26 x 7.5 cm
10.25 x 3"

MZCP20 20 x 6.5 cm
7.85 x 2.50"



Ellipse plate

Plat ellipse
Platte ellipse
Plato ellipse
Piatto ellisse

MZEP32 32 x 21 cm
12.60 x 8.25"

MZEP26 26 x 17 cm
10.25 x 6.70"

MZEP20 20 x 13 cm
7.85 x 5.10"



 Pieces per box
Pièces par boîte
Stück pro Karton
Piezas por caja
Pezzi per scatola

**Mini rectangular dish**

Coupelle rectangulaire
Schale rechteckig
Rabanera mini rectangular
Mini coppetta rettangolare

MZMR11 11 x 5,5 cm
4,25 x 2,15"

**Mini square dish**

Coupelle carrée
Schale quadratisch
Rabanera mini cuadrada
Mini coppetta quadrata

MZMS08 8 x 7,5 cm
3,15 x 2,95"

**Stackable breakfast cup**

Tasse à déjeuner empilable
Frühstückstasse stapelbar
Taza de desayuno apilable
Tazza da colazione impilabile

MZCU35 35 cl / 11,85 oz

**Stackable cappuccino cup**

Tasse à cappuccino empilable
Cappuccinotasse stapelbar
Taza cappuccino apilable
Tazza da cappuccino impilabile

MZCU28 28 cl / 9,45 oz

**Stackable tea cup**

Tasse à thé empilable
Teetasse stapelbar
Taza a té apilable
Tazza da té impilabile

MZCU23 23 cl / 7,80 oz

**Stackable coffee cup**

Tasse à café empilable
Kaffeetasse stapelbar
Taza a café apilable
Tazza da caffè impilabile

MZCU20 20 cl / 6,75 oz

**Stackable espresso cup**

Tasse à espresso
empilable
Espressotasse stapelbar
Taza a espresso apilable
Tazza da espresso
impilabile

MZCU09 8,5 cl / 2,85 oz

**Saucer**

Soucoupe
Untere
Platillo
Piattino

**MZSA26 > MZCU35/MZCU28/
MZCU23/MZCU20/
MZCU09**

26 x 10 cm / 10,30 x 3,95"

**Round saucer**

Soucoupe ronde
Untere rund
Platillo redondo
Piattino rotondo

**CLSA02 > MZCU35/MZCU28/
MZCU23/MZCU20**

17 cm / 6,70"



CLSA13 > MZCU09

13 cm / 5,10"

**Creamer**

Crémier
Milckkännchen
Lechera
Bricco da latte

MZCR15 15 cl / 5,05 oz



METROPOLIS

En

METROPOLIS creates a cosmopolitan, chic and urban atmosphere, with a hint of retro. Its relief which is pleasant to touch, emits a tasty shine.

Fr

METROPOLIS crée une atmosphère cosmopolite, chic et citadine avec une touche retro. Son relief agréable au toucher diffuse une lumière savoureuse.

De

Die Serie METROPOLIS verbreitet eine kosmopolitische, elegante und städtische Atmosphäre mit einem leichten Retro-Touch. Ihr angenehm anzufühlendes Relief sorgt für genussvolle Lichtreflexionen.

Es

METROPOLIS crea una atmósfera cosmopolita, elegante y urbana con un toque retro. Su relieve agradable al tacto emite una luz sabrosa.

It

METROPOLIS crea un'atmosfera cosmopolita, chic e cittadina con un tocco retrò. Il rilievo piacevole al tatto diffonde una luce gradevole.





METROPOLIS



Flat plate

Assiette plate
Teller flach
Plato llano
Piatto piano

MEFP31 31 cm / 12.20"



MEFP29 29 cm / 11.40"

MEFP27 27 cm / 10.65"

MEFP24 24 cm / 9.45"



MEFP21 21 cm / 8.25"

MEFP17 17 cm / 6.70"

MEFP15 15 cm / 5.90"



Coffee cup

Tasse à café
Kaffeetasse
Taza a café
Tazza da caffè

MECU20 20 cl / 6.75 oz



Saucer for coffee cup

Soucoupe pour tasse à café
Untere für Kaffeetasse
Platillo para taza a café
Piattino per tazza da caffè

MESA15 > MECU20

15 cm / 5.90"



Deep plate

Assiette creuse
Teller tief
Plato hondo
Piatto fondo

MEDP30 30 cm / 11.80"



MEDP26 26 cm / 10.25"

MEDP23 23 cm / 9.05"



Espresso cup

Tasse à expresso
Espressotasse
Taza a expreso
Tazza da espresso

MECU09 9 cl / 3.05 oz



Saucer for espresso cup

Soucoupe pour tasse à expresso
Untere für Espressotasse
Platillo para taza a expreso
Piattino per tazza da espresso

MESA13 > MECU09

13 cm / 5.10"



Coffee cup

Tasse à café
Kaffeetasse
Taza a café
Tazza da caffè

MECU35 35 cl / 11.85 oz



Saucer for coffee cup

Soucoupe pour
tasse à café
Untere für Kaffeetasse
Platillo para taza a café
Piattino per tazza da caffè

MESA17 > MECU35

17 cm / 6.70"



Creamer

Crémier
Milchkännchen
Lechera
Bricco da latte

MECR15 15 cl / 5.05 oz





Pieces per box
Pièces par boîte
Stück pro Karton
Piezas por caja
Pezzi per scatola



MINIMAX



En

MINIMAX is eclectic and full of good ideas, offering a range of items to be used alone or combined harmoniously with other series. The variety of small and large sizes provide innovative solutions for serving your most unusual culinary creations.

Fr

Éclectique et pleine de bonnes idées, MINIMAX propose une gamme d'articles à utiliser seuls ou en harmonie avec d'autres séries. L'assortiment de petites et grandes tailles procure des solutions originales à vos créations culinaires les plus insolites.

De

Mit offenem Design und voller spannender Ideen präsentiert sich die Serie MINIMAX gleichermaßen als eigenständige Serie und als harmonische Ergänzung anderer Serien. Die große Auswahl an kleinen und großen Formen eröffnet innovative Lösungen für Ihre außergewöhnlichen kulinarischen Kreationen.

Es

Ecléctica y repleta de buenas ideas, MINIMAX propone una gama de artículos para utilizar solos o en armonía con otras series. El conjunto de pequeños y grandes tamaños aporta soluciones originales a sus creaciones culinarias más insólitas.

It

Eclettica e piena di idee eccezionali, la linea MINIMAX propone una gamma di articoli da usare singolarmente o insieme ad altre serie. Grazie a un assortimento di taglie piccole e grandi, offre soluzioni originali in grado di soddisfare le creazioni culinarie più insolite.



PLATTERS AND PLATES

PLATS ET ASSIETTES

PLATTEN UND TELLER

FUENTES Y PLATOS

VASSOI I PIATTI



Oval plate

Plat ovale
Platte oval
Plato oval
Piatto ovale

MNOP33 32.5 x 13.5 cm
12.80 x 5.30"



Half-moon platter

Plat demi-lune
Halbmondplatte
Plato media luna
Piatto mezzaluna

MNMP38 38.5 x 15.5 cm
15.15 x 6.10"



Island platter

Plat île
Inselplatte
Bandeja isla
Vassoio isola

NAIP39 39 x 31 cm
15.35 x 12.20"

NAIP33 33 x 27.5 cm
13 x 10.85"



Service tray, 16 indents

Plat service, 16 encoches
Serviceplatte, 16 Flächen
Bandeja, 16 estanques
Vassoio da portata, 16 inserti

LXST39 > SPCU09 39 x 28 cm
15.35 x 11"



Leaf bowl

Bol feuille
Blattschale
Bol hoja
Coppetta foglia

NABW28 28.5 x 17 cm - 63 cl
11.20 x 6.70" - 21.30 oz

NABW22 22 x 14.5 cm - 45 cl
8.65 x 5.70" - 15.20 oz

NABW16 16.5 x 12 cm - 20 cl
6.50 x 4.70" - 6.75 oz



Cup without handle

Tasse sans anse
Tasse ohne Henkel
Taza sin asa
Tazza senza manici

SPCU09 > LXST39 9 cl / 3.05 oz



Leaf plate

Plat feuille
Blattplatte
Plato hoja
Piatto foglia

NAOP48 48.5 x 30 cm
19.10 x 11.80"

NAOP38 38 x 25.5 cm
15 x 10.05"



Drop shaped platter

Plat en forme de goutte
Platte in Tropfenform
Plato en forma de gota
Piatto a goccia

ACDS01 35.5 x 18.5 cm
14 x 7.30"

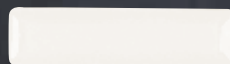

Rectangular long dish

Plat long rectangulaire
Platte lang rechteckig
Plato largo rectangular
Piatto lungo rettangolare

OPRL40 40 x 10.5 cm
15.75 x 4.15"



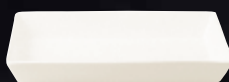

Rectangular dish
 Ravier rectangulaire
 Schale rechteckig
 Rabanera rectangular
 Coppetta rettangolare

OPCD26 26 x 16 cm - 100 cl
 10.25 x 6.30" - 33.80 oz

OPCD20 20 x 16 cm - 59 cl
 7.85 x 6.30" - 19.95 oz



OPCD18 18 x 10.5 cm - 33 cl
 7 x 4.10" - 11.15 oz



OPCD17 17 x 13 cm - 50 cl
 6.70 x 5.10" - 16.90 oz



Rectangular plate, 6 compartments
 Assiette rectangulaire,
 6 compartiments
 Platte rechteckig,
 6 Vertiefungen
 Plato rectangular,
 6 compartimentos
 Piatto rettangolare,
 6 compartimenti

OPRP6C 28 x 20 cm
 11 x 7.85"



Square plate, 4 compartments
 Assiette carrée,
 4 compartiments
 Platte quadratisch,
 4 Vertiefungen
 Plato cuadrado,
 4 compartimentos
 Piatto quadrato,
 4 compartimenti

OPSP4C 20 cm / 7.85"



Rectangular tray, 3 compartments
 Plat rectangulaire,
 3 compartiments
 Platte rechteckig,
 3 Vertiefungen
 Bandeja rectangular,
 3 compartimentos
 Vassoio rettangolare,
 3 compartimenti

OPRT19C 19 x 17 cm
 7.50 x 6.70"

SPRP3C 19.5 x 12.5 cm
 7.70 x 4.90"



Rectangular tray
 Plat rectangulaire
 Platte rechteckig
 Bandeja rectangular
 Vassoio rettangolare

OPRT24 24 x 10 cm
 9.45 x 3.95"



OPRT18 18 x 7.5 cm
 7.10 x 2.95"



MINIMAX



Bowl

Bol
Schale
Bol
Coppetta

NAMB37 37 cm - 7 cm - 120 cl
14.55" - 2.75" - 40.60 oz

NAMB31 31 cm - 8 cm - 95 cl
12.20" - 3.15" - 32.10 oz



NAMB27 27 cm - 6.5 cm - 70 cl
10.65" - 2.55" - 23.65 oz

NAMB16 16 cm - 3.5 cm - 12 cl
6.30" - 1.40" - 4.05 oz

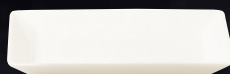

Small rectangular tray

Plat rectangulaire petit
Platte rechteckig klein
Bandeja rectangular pequeña
Vassoio rettangolare piccolo

OPTR12 12 x 7.5 cm
4.70 x 2.95"



Snack plate

Plat à snack
Snackplatte
Plato snack
Vassoio snack

OPRP18 18 x 11.5 cm
7.10 x 4.55"



Sandwich tray

Plat à sandwich
Sandwichplatte
Bandeja sándwich
Vassoio sandwich

OPST39 39 x 28 cm
15.35 x 11"



Square plate

Assiette carrée
Teller quadratisch
Plato cuadrado
Piatto quadrato

OPSP08 8 cm / 3.15"

OPSP06 6 cm / 2.35"

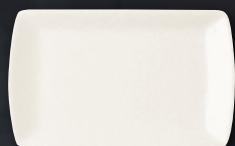

Sandwich tray

Plat à sandwich
Sandwichplatte
Bandeja sándwich
Vassoio sandwich

OPSP45 45 x 15 cm
17.75 x 6"



OPSP35 35 x 15 cm
13.80 x 5.90"

OPST24 24 x 14 cm
9.45 x 5.55"

OPSP14 14 x 8 cm
5.50 x 3.15"



Half-moon plate

Assiette demi-lune
Teller Halbmond
Plato media luna
Piatto mezzaluna

OPMP01 21 x 12 cm
8.25 x 4.70"

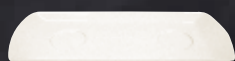

Sandwich tray, 2 indents 55 mm / 2.15"

Plat à sandwich,
2 empreintes 55 mm/2.15"
Sandwichplatte,
2 Vertiefungen 55 mm/2.15"
Bandeja sándwich,
2 estanques 55 mm/2.15"
Vassoio sandwich,
2 inserti 55 mm/2.15 "

OPSP35IN 35 x 15 cm
13.80 x 5.90"

OPSP14IN 13.5 x 8 cm
5.35 x 3.25"



Oval plate rimless

Plat ovale sans bord
Platte oval ohne Rand
Fuente oval sin borde
Piatto ovale senza falda

OPOP19 19 x 15.5 cm
7.50 x 6.10"



**DEEP PLATTERS
PLATS CREUX
PLATTEN TIEF
FUENTES HONDO
PIATTI FONDI**



Square bowl

Bol carré
Schale quadratisch
Bol cuadrado
Coppetta quadrata

OPSB15 15 cm - 7 cm - 70 cl / 5.90" - 2.75" - 23.65 oz



OPSB12 12 cm - 3.5 cm - 20 cl / 4.70" - 1.40" - 6.75 oz



OPSB09 9 cm - 5 cm - 17 cl / 3.55" - 1.95" - 5.75 oz



OPSB08 8 cm - 4 cm - 10.5 cl / 3.15" - 1.55" - 3.55 oz



OPSB07 7 cm - 3.5 cm - 7 cl / 2.75" - 1.40" - 2.35 oz



OPSB04 4 cm - 2 cm - 2 cl / 1.55" - 0.80" - 0.70 oz



Triangular bowl

Bol triangulaire
Schale dreieckig
Bol triangular
Coppetta triangolare

OPTB12 12 cm - 25.5 cl / 4.70" - 8.60 oz

OPTB10 10 cm - 15.5 cl / 3.75" - 5.25 oz



Deep bowl boat

Bol profond bateau
Bootschale tief
Bol hondo barco
Coppetta fonda barca

MNDB116 23 x 13 cm - 10.5 cm - 116 cl
8.95 x 5.10" - 4.15" -
39.20 oz



Lid for deep bowl boat

Couvercle pour bol
profond bateau
Deckel für Bootschale tief
Tapa para bol hondo barco
Coperchio per coppetta
fonda barca

MNDBLD01 > **MNDB116**



Deep bowl boat

Bol profond bateau
Bootschale tief
Bol hondo barco
Coppetta fonda barca

MNDB50 19.5 x 12 cm - 7 cm - 60 cl
7.70 x 4.60" - 2.75" - 20.30 oz



Bowl boat

Bol bateau
Bootschale
Bol barco
Coppetta barca

MNSB68 22.5 x 13.5 cm - 8 cm - 68 cl
8.85 x 5.30" - 3.15" - 23 oz



MINIMAX



Boat dish

Plat bateau
Bootschale
Plato barco
Piatto barca

MNSB44 23 x 13 cm - 5.5 cm - 44 cl
9.05 x 5.10" - 2.20" - 14.90 oz



Oval dish with grip

Plat à oreilles ovale
Schale oval mit Griffen
Plato oval con asas
Piatto ovale con alette

OPOD30 30 x 16 cm - 7.8 cm - 78 cl
11.80 x 6.30" - 26.35 oz



Lid for boat dish

Couvercle pour plat
bateau
Deckel für Bootschale
Tapa para plato barco
Coperchio per copetta
barca

MNSBLD01 > **MNSB44**



Boat dish

Plat bateau
Bootschale
Plato barco
Piatto barca

MNSB34 21 x 11.5 cm - 5.2 cm - 34 cl
8.20 x 4.55" - 2.05" - 11.50 oz

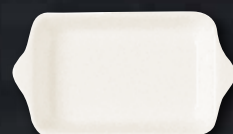

Rectangular dish with grip

Plat rectangulaire à poignées
Teller rechteckig mit Griffen
Plato rectangular con asas
Piatto rettangolare con manici

OPRT16 16.3 x 9.5 cm - 15 cl
6.40 x 3.75" - 4.90 oz



Bowl boat

Bol bateau
Bootschale
Bol barco
Coppetta barca

MNSB32 17 x 10.5 cm - 6.5 cm - 32 cl
6.70 x 4.15" - 2.55" - 10.80 oz



Stackable oval pie dish

Plat ovale empilable
Platte oval stapelbar
Plato oval apilable
Piatto per torta ovale impilabile

OPOS20 20 x 12 cm - 42 cl
7.85 x 4.70" - 14.20 oz



Mini boat bowl

Mini bol bateau
Mini Bootschale
Mini bol barco
Mini coppetta barca

MNOD09 15 x 8.5 cm - 3.5 cm - 11 cl
5.85 x 3.35" - 1.40" - 3.70 oz

MNOD05 7.3 x 4.5 cm - 3 cm - 3 cl
2.85 x 1.75" - 1.20" - 1 oz



Pie dish

Plat à gratin
Platte für Gratin
Plato a gratin
Piatto per torta

OPPD15 15 x 11 cm - 28 cl
5.90 x 4.35" - 9.45 oz

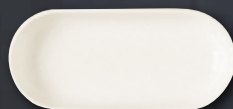

Oval bowl stackable

Plat ovale empilable
Schale oval stapelbar
Cuenco oval apilable
Coppetta ovale impilabile

OPRB17 17 x 8 cm - 15 cl
6.70 x 3.15" - 5.05 oz





Round dish with grip
 Plat à oreilles rond
 Schale rund mit Griffen
 Plato redondo con asas
 Piatto rotondo con alette

OPRD16 21.5 x 18 cm - 45 cl
 8.45 x 7.10" - 15.20 oz



ARTICLES WITH LID
ARTICLES AVEC
COUVERCLE
ARTIKEL MIT DECKEL
ARTÍCULOS CON TAPA
ARTICOLI CON COPERCHIO



Rectangular tureen & lid
 Terrine rectangulaire & couvercle
 Terrine rechteckig & Deckel
 Tarrina rectangular & tapa
 Terrina rettangolare & coperchio

OPTU23 23 x 18 cm - 14 cm - 160 cl
 9.05 x 7.10" - 5.40" - 54.10 oz

OPTU20 20 x 15 cm - 12 cm - 104 cl
 7.70 x 6.05" - 4.55" - 35.15 oz

OPTU16 16 x 13.5 cm - 10 cm - 60 cl
 6.45 x 5.30" - 3.95" - 20.30 oz

OPTU15 15 x 12 cm - 9 cm - 39 cl
 5.90 x 4.65" - 3.55" - 13.20 oz

OPTU13 13 x 10 cm - 8 cm - 30 cl
 5.10 x 4" - 3.05" - 10.15 oz

OPTU12 12 x 9 cm - 7 cm - 20 cl
 4.60 x 3.60" - 2.75" - 6.75 oz



Handi bowl & lid
 Bol Handi & couvercle
 Handi Schale & Deckel
 Bol Handi & tapa
 Coppetta bombata Handi
 & coperchio

OPHB150 18.5 cm - 13 cm - 150 cl
 7.30" - 5.10" - 50.70 oz



OPHB89 19.5 cm - 10 cm - 90 cl
 7.70" - 3.95" - 30.45 oz



OPHB85 16.5 cm - 11 cm - 85 cl
 6.50" - 4.35" - 28.75 oz



OPHB50 15.5 cm - 9 cm - 50 cl
 6.10" - 3.55" - 16.90 oz



Lid for handi bowl
 Couvercle pour bol Handi
 Deckel für Handi Schale
 Tapa para bol Handi
 Coperchio per coppetta
 bombata Handi

OPHBLD150 > OPHB150



OPTBLD89 > OPHB89



OPHBLD85 > OPHB85



OPHBLD50 > OPHB50



MINIMAX



Bowl & lid

Bol & couvercle
Schale & Deckel
Bol & tapa
Coppetta & coperchio

OPBW15 15 cm - 12.5 cm - 37 cl
5.90" - 4.90" - 12.50 oz



Lid for bowl

Couvercle pour bol
Deckel für Schale
Tapa para bol
Coperchio per coppetta

OPBWD15



Jungle CS bowl & lid

Bol jungle CS & couvercle
Dschungelschale CS &
Deckel
Bol jungle CS & tapa
Zuppiera Jungle con
manici & coperchio

NAJB57 57 cl / 19.25 oz



Lid for jungle CS bowl

Couvercle
bol jungle CS
Deckel für
Dschungelschale CS
Tapa para bol jungle CS
Coperchio per zuppiera
Jungle con manici

NALD01



Noodle bowl

Bol à nouilles
Nudelschale
Noodle Bol
Coppetta per pasta

OPNB15 15 cm - 6 cm - 63 cl
5.90" - 2.35" - 21.30 oz



Round bowl Katori

Bol rond Katori
Schale rund Katori
Bol redondo Katori
Coppetta rotonda Katori

MNRD10 10 cm - 4.5 cm - 18 cl
3.95" - 1.75" - 6.10 oz



Stackable salad bowl

Saladier empilable
Salatschale staplbar
Ensaladera apilable
Insalatiera impilabile

OPBW10 11 cm - 5 cm - 23.5 cl
4.20" - 1.85" - 7.95 oz

OPBW09 9 cm - 4 cm - 12 cl
3.55" - 1.55" - 4.05 oz

OPBW07 7.5 cm - 3.5 cm - 7 cl
3" - 1.40" - 2.35 oz



Round stackable dish

Ravier rond empilable
Schale rund stapelbar
Bol redondo apilable
Coppetta rotonda impilabile

OPBW06 6 cm - 2.5 cm - 3 cl
2.35" - 0.95" - 1 oz



Cup

Tasse
Tasse
Taza
Tazza

OPCU15 15 cl / 5.05 oz





Stackable mug Casino
Chope Casino empilable
Becher Casino stapelbar
Mug Casino apilable
Mug Casino impilabile

OPCM23 23 cl / 7.80 oz

12



Stackable mug Baltic
Chope Baltic empilable
Becher Baltic stapelbar
Mug Baltic apilable
Mug Baltic impilabile

OPBMG23 23 cl / 7.80 oz

12



Mug Ambrosia
Chope Ambrosia
Becher Ambrosia
Mug Ambrosia
Mug Ambrosia

ACAM35 35 cl / 11.85 oz

ACAM25 25 cl / 8.45 oz

12



Mug Sunshine
Chope Sunshine
Becher Sunshine
Mug Sunshine
Mug Sunshine

OPSMG33 8 cm - 33 cl
3.15" - 11.15oz

OPMG28 8 cm - 28 cl
3.25" - 9.45 oz

OPSMG24 7.5 cm - 24 cl
3" - 8.10 oz

OPSMG18 6.5 cm - 18 cl
2.55" - 6.10 oz

OPSMG09 5 cm - 9 cl
1.95" - 3.05 oz

12



ACCESSORIES
ACCESSOIRES
ZUBEHÖR
ACCESORIOS
ACCESSORI

Square fruit bowl
Coupelle carrée
Schälchen quadratisch
Bol frutero cuadrado
Fruttiera quadrata

OPFB10 10 cm - 18 cl
3.95" - 6.10 oz

12



Sauce cup & lid
Moutardier & couvercle
Senftopf & Deckel
Salsera & tapa
Salsiera & coperchio

OPCU12 7 cm - 6.5 cm - 12 cl
2.75" - 2.55" - 4.05 oz

12

Lid for sauce cup
Couvercle pour moutardier
Deckel für Senftopf
Tapa para salsera
Coperchio per salsiera

OPLD01

12



Spoon for sauce cup
Cuillère pour moutardier
Löffel für Senftopf
Cuchara para salsera
Cucchiaio per salsiera

OPSP12 12 cm / 4.70"

12



Sauce bottle & lid
Saucière & couvercle
Saucenkännchen & Deckel
Salsera & tapa
Salsiera & coperchio

ACSY01 9 cm - 11 cl
3.55" - 3.70 oz

12

Lid for sauce bottle
Couvercle pour saucière
Deckel für Saucenkännchen
Tapa para salsera
Coperchio per salsiera

ACSYLD01

24

MINIMAX



Magic oil/vinegar

Huiler/vinaigrier
Öl- /Essigkanne
Aceitera/vinagrero
Bricco da olio/acetato

ACOV01 20 cl / 6.75 oz

12

Lid for vinegar pot

Couvercle pour vinaigrier
Deckel für Essigkanne
Tapa para vinagrero
Coperchio per bricco da acetato

ACOVLD

24



Yin Yang saucer

Yin Yang saucière
Yin Yang Sauciere
Salsera Yin Yang
Salsiera Yin Yang

ACYY01 10 cm / 3.95"

24



Golfball pepper shaker

Poivrier golf
Pfefferstreuer Golf
Pimentero pelota golf
Pepiera palla golf

OPGB01 4 x 4 cm
1.55 x 1.55"

6



Golfball salt shaker

Salière golf
Salzstreuer Golf
Salero pelota golf
Saliera palla golf

OPGB02 4 x 4 cm
1.55 x 1.55"

6



Pepper shaker

Poivrier
Pfefferstreuer
Pimentero
Pepiera

OPPS01 5.5 x 2.5 cm - 4 cm
2.15 x 0.95" - 1.55"

12



Salt shaker

Salière
Salzstreuer
Salero
Saliera

OPSS01 5.5 x 2.5 cm - 4 cm
2.15 x 0.95" - 1.55"

12



Soup spoon

Cuillère à soupe
Suppenlöffel
Cuchara de sopa
Cucchiaio da tavola

ACSP01 12 cm / 4.70"

24



Stand for spoon

Reposoir à cuillère
Stand für Löffel
Reposa cucharas
Porta cucchiaino

ACSS01 11.5 x 5.5 cm
4.55 x 2.15"

12



Chopstick holder

Porte-baguettes
Stäbchenhalter
Reposa palillos
Portabacchette

ACCS01 6 x 2 cm / 2.35 x 0.80"

24

**MINIATURES
MINIATURES
MINIATUREN
MINIATURAS
MINIATURE**



High cube
Cube haut
Kubus hoch
Cubo alto
Coppetta a cubo alta
OPSD01 5 cm - 5.5 cm - 9 cl
1.95" - 2.15" - 3.05 oz
12



Small cube
Cube bas
Kubus klein
Cubo bajo
Coppetta a cubo piccola
OPSD02 5 cm - 4.5 cm - 6 cl
1.95" - 1.75" - 2.05 oz
12



Square creamer/gravy boat
Crémier/saucière carré
Saucière/Milchkännchen quadratisch
Salsera/lechera cuadrada
Salsiera/bricco da latte quadrato
OPSD03 5 cm - 6 cm - 8 cl
1.95" - 2.30" - 2.70 oz
12



Mini pan with grip
Mini poêlon avec poignée
Mini Pfanne mit Griff
Mini sartén con asa
Mini tegame
MNMP01 6.2 cm / 2.45"
12



Square sauce dish
Bol à sauce carré
Saucenschale quadratisch
Bol salsa cuadrado
Salsiera quadrata
ACSD01 7.5 cm - 3 cm
2.95" - 1.20"
6



Rectangular Twin sauce bowl
Coupelle à sauce double
Doppelte Saucenschale
rechteckig
Bol salsa doble
rectangular
Coppetta per salsa doppia
rettangolare
ACTS01 14.5 x 7 cm - 3 cm
5.70 x 2.75" - 1.20"
6



Mini boat bowl
Mini bol bateau
Mini Bootschale
Mini bol barco
Mini coppetta barca
MNOD05 7.5 x 4.5 cm - 3 cm - 3 cl
2.85 x 1.75" - 1.20" - 1 oz
6



Miniature triangular boat
Miniature bateau
triangulaire
Miniatur Boot dreieckig
Miniatura barco triangular
Miniatura barca triangolare
MNTD01 7.5 x 6 cm - 3 cm
2.95 x 2.35" - 1.20"
6

MINIMAX



Miniature square boat
Miniature bateau carré
Miniatur Boot quadratisch
Miniatura barco cuadrado
Miniatura barca quadrata

MNSD01 6 cm - 3 cm - 6 cl
2.35" - 1.20" - 2.05 oz



Ramekin with grooves
Ramequin plissé
Auflaufform gerillt
Ramequin estriado
Stampo scanalato

ACRG10 10 cm - 33 cl
3.95" - 11.15 oz

ACRG09 9 cm - 19 cl
3.55" - 6.40"



Asymmetric dish
Coupelle asymétrique
Schale asymmetrisch
Bol asimétrico
Coppetta asimmetrica

OPAB06 6 cm - 2 cm
2.35" - 0.80"

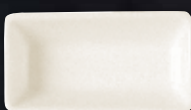

Rectangular dish
Ravier rectangulaire
Schale rechteckig
Platillo rectangular
Coppetta rettangolare

ACRD10 10 x 6 cm / 3.95 x 2.30"



Miniature round bowl
Miniature bol rond
Miniaturschale rund
Miniatura bol redondo
Miniatura coppetta
rotonda

OPCU05 5 cl / 1.70 oz



Moon plate
Plateau lune
Mondplatte
Plato luna
Piatto luna

OPMP01 21 x 12 cm
8.25 x 4.70"



Egg cup
Coquetier
Eierbecher
Huevera
Portauovo

OPEG01



Creamer
Crémier
Milchkännchen
Lechera
Bricco da latte

OPCR09M 6 cm - 7.2 cm - 9 cl
2.30" - 2.85" - 3.05 oz



Square bowl
Bol carré
Schale quadratisch
Bol cuadrado
Coppetta quadrata

OPSB04 4 cm - 2 cm - 2 cl
1.55" - 0.80" - 0.70 oz



Jigsaw plate
Plat Jigsaw
Platte Jigsaw
Fuente Jigsaw
Piatto Jigsaw

OPJP20 20 x 15 cm
7.90 x 5.90"



Jigsaw bowl
Bol Jigsaw
Schale Jigsaw
Bol Jigsaw
Coppetta Jigsaw

OPJB18 12.5 x 9 cm - 18 cl
4.90 x 3.65" - 6.10 oz





Triangular plate, 3 compartments
 Plat triangulaire, 3 compartiments
 Platte dreieckig, 3 Vertiefungen
 Bandeja triangular, 3 compartimentos
 Piatto triangolare, 3 compartimenti

ACTR01 30 x 26 cm
 11.70 x 10.20"



Trio dish
 Coupelle triple
 Triple Schale
 Rabanera triple
 Coppetta tripla

MNTR01 15 x 14.5 cm
 6 x 5.75"



Butterfly dish
 Plat papillon
 Schmetterlingsschale
 Plato mariposa
 Copetta di farfalla

NABD16 17 x 13 cm
 6.65 x 5.05"



Glove dish
 Coupelle
 Schale
 Rabanera
 Coppetta

MNGD01 13 x 12 cm
 5.10 x 4.70"



Halo dish
 Ravier Halo
 Schale Halo
 Rabanera Halo
 Coppetta Halo

MNHD01 13 x 10 cm
 5.10 x 3.95"



Sauce dish, 4 indents
 Ravier sauce, 4 empreintes
 Schale, 4 Ringe
 Platillo, 4 estanques
 Salsiera, 4 inserti

MNID04 13.5 x 11 cm
 5.35 x 4.20"



Lemon dish
 Ravier citron
 Zitronenschale
 Platillo limon
 Piatto limone

MNLN01 13.5 x 8 cm
 5.35 x 3.20"



NABUR

En

Inspired by nature, NABUR reveals sculptural, organic-curved shapes. Like a paean to difference, shapes and materials, NABUR celebrates the boldness of leading chefs.

Fr

Inspirée de la nature, NABUR révèle des formes sculpturales aux courbes organiques. Ode à la différence, aux formes et à la matière, NABUR célèbre l'audace des plus grands chefs.

De

Von der Natur inspiriert, fällt die Serie NABUR durch bildhauerische Formen und organisch geformte Linien auf. NABUR ist eine Ode an die Vielfalt der Formen und Materialien und eine Reminiszenz an die Kühnheit der großen Meisterköche.

Es

NABUR, inspirada en la naturaleza, revela formas esculturales con curvas orgánicas. Como en una oda a la diferencia, a las formas y a la materia, NABUR elogia la audacia de los mejores chefs.

It

Ispirata alla natura, la linea NABUR sfoggia forme scultoree dalle curve organiche. Vera e propria ode alla diversità, alle forme e alla materia, NABUR celebra l'audacia dei migliori chef.

DESIGN BY MIKAELA DOERFEL





NABUR



Dinner plate, 2 basins

Assiette, 2 bassins
Teller, 2 Vertiefungen
Plato, 2 zonas
Piatto, 2 inserti

NBFP32 32 x 26.5 cm
12.60 x 10.45"



Bowl

Bol
Schale
Bol
Coppetta

NBSB23 23 x 19.5 cm - 6.5 cm - 77 cl
9.05 x 7.70" - 2.50" - 26.05 oz

NBSB19 19 x 16 cm - 5.8 cm - 61 cl
7.50 x 6.20" - 2.30" - 20.65 oz

NBSB16 16 x 13 cm - 5 cm - 30 cl
6.30 x 5.10" - 1.95" - 10 oz



Dinner coupe plate

Assiette coupe
Teller coup
Plato coupe
Piatto senza falda

NBFP31 31 x 26.5 cm
12.20 x 10.45"



NBFP27 27 x 22.5 cm
10.65 x 8.85"



Dip bowl

Coupelle
Schälchen
Bol hondo
Coppetta

NBDB08 8 x 6.5 cm - 2 cm - 4 cl
3.15 x 2.55" - 0.80" - 1.35 oz



Breakfast plate, 2 basins

Assiette, 2 bassins
Teller, 2 Vertiefungen
Plato desayuno, 2 zonas
Piatto, 2 inserti

NBFP24 > NBCU26
24 x 20 cm
9.45 x 7.85"



Sauce boat/creamer

Saucière/crémier
Sauciere/Milchkännchen
Salsera/lechera
Salsiera/bricco da latte

NBCR25 14 x 10 cm - 4.5 cm - 25 cl
5.50 x 3.85" - 1.75" - 8.45 oz



NBCR15 12.5 x 8.5 cm - 4 cm - 15 cl
4.90 x 3.35" - 1.55" - 5.05 oz

NBCR06 9 x 6.5 cm - 4 cm - 6 cl
3.60 x 2.50" - 1.55" - 2.05 oz



Party plate

Assiette cocktail
Cocktailteller
Plato cóctel
Piatto cocktail

NBPP22 22 x 15.5 cm
8.65 x 6.10"



Pieces per box
Pièces par boîte
Stück pro Karton
Piezas por caja
Pezzi per scatola

**Breakfast cup**

Tasse à déjeuner
Frühstückstasse
Taza de desayuno
Tazza da colazione

NBCU34 9 cm - 34 cl
3.45" - 11.50 oz

**Espresso cup**

Tasse à expresso
Espressotasse
Taza a expreso
Tazza da espresso

NBCU09 6 cm - 9 cl
2.35" - 3.05 oz

**Coffee/tea cup**

Tasse à café/thé
Kaffee-/Teetasse
Taza a café/té
Tazza da caffè/tè

NBCU26 9 cm - 26 cl
3.45" - 8.80 oz

**Saucer for espresso cup**

Soucoupe pour tasse à
expresso
Untere für Espressotasse
Platillo para taza a expreso
Piattino per tazza da
espresso

NBSA15 > NBCU09

15 x 12.5 cm
5.90 x 4.90"

**Saucer for breakfast cup
and coffee/tea cup**

Soucoupe pour tasse à déjeuner
et tasse à café/thé
Untere für Frühstückstasse
und für Tee/Kaffeetasse
Platillo para taza de desayuno
y taza café/té
Piattino per Tazza da colazione
e da caffè/tè

NBSA18 > NBCU34 / NBCU26

16 x 13.5 cm
6.30 x 5.25"

**Teapot & lid**

Théière & couvercle
Teekanne & Deckel
Tetera & tapa
Teiera & coperchio

NBTP80 80 cl / 27.05 oz

**Lid for teapot**

Couvercle pour théière
Deckel für Teekanne
Tapa para tetera
Coperchio per teiera

NBTPLD2

**Coffee pot & lid**

Cafetière & couvercle
Kaffeekanne & Deckel
Cafetera & tapa
Caffettiera & coperchio

NBCP50 50 cl / 16.90 oz

**Lid for coffee pot**

Couvercle pour cafetière
Deckel für Kaffeekanne
Tapa para cafetera
Coperchio per caffettiera

NBCPLD1



NANO

En

NANO's lines are exquisitely pure displaying a traditional Asian charm. This series' pared-down style means it can be adapted for different dishes and uses.

Fr

Avec un charme traditionnel venu d'Asie, NANO présente des lignes d'une exquise pureté. Son style dépouillé permet à cette série de s'adapter à des plats et des usages variés.

De

Mit ihrer klaren Linienführung vermittelt die Serie NANO traditionellen asiatischen Charme. Durch die nüchterne Gestaltung kann die Serie für zahlreiche Gerichte und Einsatzbereiche verwendet werden.

Es

Con un encanto venido desde Asia, NANO presenta líneas de exquisita pureza. Su estilo austero permite que esta serie se adapte a una amplia variedad de platos y usos.

It

Con il suo fascino tradizionale di derivazione asiatica, NANO presenta delle linee dalla purezza semplicemente squisita. Il suo stile essenziale consente a questa serie di adattarsi a piatti e usi di ogni tipo.





NANO



Rectangular serving plate

Assiette à servir
rectangulaire
Servierteller rechteckig
Plato para servir
rectangular
Piatto da portata
rettangolare

EDRG33IV 33.5 x 18 cm
13.20 x 7.15"



Deep coupe plate

Assiette creuse coupe
Teller tief coup
Plato hondo coupe
Platto fondo senza falda
NNDP30 30 cm - 190 cl / 11.80" - 64.25 oz



NNDP28 28 cm - 125 cl / 11" - 42.25 oz



Square plate

Assiette carrée
Teller quadratisch
Plato cuadrado
Piatto quadrato

EDSQ30IV 30 cm / 11.80"

EDSQ27IV 27 cm / 10.65"

EDSQ25IV 24.5 cm / 9.65"



Deep coupe plate

Assiette creuse coupe
Teller tief coup
Plato hondo coupe
Platto fondo senza falda

BUBC30 30 cm - 190 cl / 11.80" - 64.25 oz



BUBC26 26 cm - 120 cl / 10.25" - 40.60 oz

NNDP23 23 cm - 69 cl / 9.05" - 23.35 oz



Square salad bowl

Saladier carré
Salatschale quadratisch
Ensaladera cuadrada
Insalatiera quadrata

EDSB70IV 20 cm - 7 cm - 140 cl
7.85" - 2.75" - 47.35 oz

EDSB45IV 20 cm - 6 cm - 100 cl
7.85" - 2.35" - 33.80 oz



Butter dish

Assiette à beurre
Butterschale
Plato mantequilla
Piatto da burro

NNBD09 9 cm / 3.55"

NNBD07 7 cm / 2.75"



Flat coupe plate

Assiette coupe plate
Teller flach coup
Plato llano coupe
Piatto piano senza falda

NNPR31 31 cm / 12.20"



NNPR29 29 cm / 11.40"

NNPR28 28 cm / 11"

NNPR27 27 cm / 10.65"

NNPR24 24 cm / 9.45"

NNPR21 21 cm / 8.25"



NNPR18 18 cm / 7.10"

NNPR15 15 cm / 5.90"



Oval platter

Plat ovale
Platte oval
Fuente oval
Piatto ovale

NNOP36 36 x 27 cm / 14.15 x 10.65"

NNOP32 32 x 23 cm / 12.60 x 9.05"



NNOP26 26 x 19 cm / 10.25 x 7.50"

NNOP21 21 x 15 cm / 8.25 x 5.90"



Cereal bowl

Bol à céréales
Müsli-Schale
Bol a cereales
Coppetta per cereali

NNBW20 20 cm - 6 cm - 90 cl

7.85" - 2.35" - 30.45 oz





Non stackable bowl
 Bol non empilabile
 Schale nicht stapelbar
 Bol no apilable
 Coppetta non impilabile

NNBW12 12 cm - 5.5 cm - 27 cl
 4.70" - 2.15" - 9.15 oz

NNBW10 10 cm - 5 cm - 16 cl
 3.95" - 1.95" - 5.40 oz

NNBW09 9 cm - 4 cm - 11 cl
 3.55" - 1.55" - 3.70 oz



Rice bowl
 Bol à riz
 Reisschale
 Bol arroz
 Coppetta per riso

NNRB16 16 cm - 6.5 cm - 58 cl
 6.30" - 2.55" - 19.60 oz



Cream soup bowl & lid
 Bol à bouillon & couvercle
 Suppentasse & Deckel
 Bol consommé & tapa
 Scodella per zuppa & coperchio

NNCS27 12 cm - 11 cm - 27 cl
 4.70" - 4.35" - 9.15 oz



Lid for cream soup bowl
 Couvercle pour bol à bouillon
 Deckel für Suppentasse
 Tapa para bol consommé
 Coperchio per scodella per zuppa

NNCS27LD



Saucer for soup bowl
 Soucoupe pour bol à bouillon
 Untere für Suppentasse
 Platillo para bol consommé
 Piattino per scodella per zuppa

NNST16 > NNCS27

16 cm / 6.30"



Bowl & lid
 Bol & couvercle
 Schale & Deckel
 Bol & tapa
 Coppetta & coperchio

NNCU17 9 cm - 9.5 cm - 17 cl
 3.55" - 3.75" - 5.75 oz



Saucer for bowl
 Soucoupe pour bol
 Untere für Schale
 Platillo para bol
 Piattino per coppetta

NNSA10 10 cm / 3.95"



Teapot & lid
 Théière & couvercle
 Teekanne & Deckel
 Tetera & tapa
 Teiera & coperchio

NNTP110 110 cl / 37.20 oz

NNTP40 40 cl / 13.55 oz



Lid for teapot
 Couvercle pour théière
 Deckel für Teekanne
 Tapa para tetera
 Coperchio per teiera

NNTPLD2 > NNTP110

NNTPLD1 > NNTP40



Creamer
 Crémier
 Milchkännchen
 Lechera
 Bricco da latte

NNCR15 15 cl / 5.05 oz



NANO



Sugar bowl & lid

Sucrier & couvercle
Zuckerdose & Deckel
Azucarero & tapa
Zuccheriera & coperchio

NNSU25 25 cl / 8.45 oz

6

Lid for sugar bowl

Couvercle pour sucrier
Deckel für Zuckerdose
Tapa para azucarero
Coperchio per zuccheriera

NNSULD

12



Oil/vinegar/soja sauce pot stand

Support à huilier/vinaigrier/pot à sauce soja
Platte für Öl/Essig/Sojasoße
Platillo para aceitera/vinagrera/salsa soja
Vassoio per bricco da olio/aceto/salsa di soja

NNST19 19 x 11 cm
7.50 x 4.35"

12



Spoon

Cuillère
Löffel
Cuchara
Cucchiaio

NNSP15 15 cm / 5.90"

NNSP14 14 cm / 5.50"

12



Double cubicle dish

Plat à sauce,
2 compartiments
Doppelsaucenschale
Plato a salsa rectangular,
2 compartimientos
Ciotola per salse,
2 compartimenti

NNCD02 9 cm / 3.55"

12



Spoon/chopstick holder

Cuillère/repose baguettes
Löffel/Stäbchenhalter
Cuchara/soporte palillos
Cucchiaio/portabacchette

NNST07 7 cm / 2.75"

12



Oil/vinegar/soy sauce pot

Huiler/vinaigrier/
pot à sauce soja
Kanne für Öl/Essig/
Sojasoße
Aceitera/vinagrera/
jarra a salsa soja
Bricco da olio/aceto/
salsa di soja

NNOV12 12 cl / 4.05 oz

12



Wine cup

Coupe à vin
Weinbecher
Copa de vino
Tazza da vino

NNWC01 5.5 cm - 1.2 cl
2.15" - 0.40 oz

6

Lid for vinegar pot

Couvercle pour vinaigrier
Deckel für Essigkanne
Tapa para vinagrero
Coperchio per bricco da aceto

NNOVLD

12

Pieces per box
Pièces par boîte
Stück pro Karton
Piezas por caja
Pezzi per scatola



NORDIC

En

NORDIC's rectilinear silhouette and minimalist simplicity give it characteristic style. Designed specifically for professionals, NORDIC is easily stackable. All of its items have been designed to be infinitely modular.

Fr

NORDIC possède un style caractéristique avec une silhouette rectiligne d'une sobriété minimaliste. Spécialement conçue pour les professionnels, NORDIC s'empile à merveille. Chacune de ses pièces est pensée pour être modulable à l'infini.

De

NORDIC besitzt einen charakteristischen Stil mit einer geradlinigen Silhouette und minimalistischer Zurückhaltung. Die Serie wurde speziell für den professionellen Bereich entworfen und lässt sich wunderbar stapeln. Jedes einzelne Teil ist so konzipiert, dass es uneingeschränkt modular eingesetzt werden kann.

Es

NORDIC posee un estilo característico con una silueta rectilínea de una sobriedad minimalista. NORDIC, especialmente concebida para los profesionales, se apila maravillosamente. Cada una de sus piezas está pensada para poder ser modulable hasta el infinito.

It

La serie NORDIC presenta uno stile caratteristico con una silhouette che predilige linee rette, sobrie e minimaliste. Appositamente concepita per i professionisti, NORDIC si impila a meraviglia. Ogni pezzo è stato pensato per essere modulabile all'infinito.





NORDIC



Flat plate with rim
Assiette plate à aile
Teller flach mit Rand
Plato llano con ala
Piatto piano con falda

NOFP32 32 cm / 12.60"

NOFP28 28 cm / 11"

NOFP24 24 cm / 9.45"



Mini plate with rim
Mini assiette à aile
Miniteller mit Rand
Mini plato con borde
Mini piatto con falda

NOBD01 6 cm / 2.35"



Rimless flat plate/lid
Assiette plate sans aile/
couverture
Teller flach ohne Rand/
Deckel

Plato llano sin ala/tapa
Piatto piano senza falda/
coperchio

NOLD27 > NODP27 NEW

27 cm / 10.65"

NOLD23 > NODP23

23 cm / 9.05"



NOLD20 > NODP20

20 cm / 7.85"

NOLD16 > NOBW16

16 cm / 6.30"

NOLD14 > NOBW14

14 cm / 5.50"

NOLD12 > NOBW12

12 cm / 4.70"



Deep plate
Assiette creuse
Teller tief
Plato hondo
Piatto fondo

NODP27 NEW

27 cm / 10.65"

NODP23 > NOFP32

23 cm / 9.05"

NODP20 > NOFP28

20 cm / 7.85"



Bowl

Bol

Schale

Bol

Coppetta

NOBW16 16 cm - 7 cm - 100 cl
6.30" - 2.75" - 33.80 oz



NOBW14 14 cm - 6 cm - 68 cl

5.50" - 2.35" - 23 oz

NOBW12 12 cm - 5 cm - 48 cl

4.70" - 1.95" - 16.25 oz



Mise en bouche/cup

Mise en bouche/tasse

Mise en bouche/Tasse

Mise en bouche/taza

Mise en bouche/tazza

NOMB1 9 cl / 3.05 oz



Breakfast cup

Tasse à déjeuner

Frühstückstasse

Taza de desayuno

Tazza da colazione

NOCU30 30 cl / 10.15 oz



Saucer for Breakfast/tea cup

Soucoupe pour tasse à déjeuner/thé

Untere für Frühstücks/Teetasse

Platillo para taza a desayuno/té

Piattino per tazza da colazione/té

NOSA3 > NOCU30

15.5 cm / 6.10"



**Tea cup**

Tasse à thé
Teetasse
Taza a té
Tazza da tè

NOCU23 23 cl / 7.80 oz

12

**Saucer for Breakfast/tea cup**

Soucoupe pour tasse à déjeuner/thé
Untere für Frühstück/Teetasse
Platillo para taza a desayuno/té
Piattino per tazza da colazione/té

NOSA3 > NOCU23

15.5 cm / 6.10"

6

**Coffee cup**

Tasse à café
Kaffeetasse
Taza a café
Tazza da caffè

NOCU20 20 cl / 6.75 oz

12

**Saucer for coffee cup**

Soucoupe pour tasse à café
Untere für Kaffeetasse
Platillo para taza a café
Piattino per tazza da caffè

NOSA2 > NOCU20

14 cm / 5.50"

6

**Espresso cup**

Tasse à expresso
Espressotasse
Taza a expreso
Tazza da espresso

NOCU09 9 cl / 3.05 oz

12

**Saucer for espresso cup**

Soucoupe pour tasse à
expresso
Untere für Espressotasse
Platillo para taza a expreso
Piattino per tazza da
espresso

NOSA1 > NOCU09

10 cm / 3.95"

12

**Mug**

Chope
Becher
Mug
Mug

NOMG33 33 cl / 11.15 oz

6



NORDIC



Coffee pot & lid

Cafetière & couvercle
Kaffeekanne & Deckel
Cafetera & tapa
Caffettiera & coperchio

NOCP100 100 cl / 33.80 oz

NOCP40 40 cl / 13.55 oz



Creamer

Crémier
Milchkännchen
Lechera
Bricco da latte

NOCR50 50 cl / 16.90 oz

NOCR15 15 cl / 5.05 oz



Lid for coffee pot

Couvercle pour cafetière
Deckel für Kaffeekanne
Tapa para cafetera
Coperchio per caffettiera

NOCPD2 > **NOCP100**

NOCPD1 > **NOCP40**



Pepper shaker

Poivrier
Pfefferstreuer
Pimentero
Pepiera

NOPS01



Salt shaker

Salière
Salzstreuer
Salero
Saliera

NOSS01



Teapot & Lid

Théière & couvercle
Teekanne & Deckel
Tetera & tapa
Teiera & coperchio

NOTP100 100 cl / 33.80 oz

NOTP40 40 cl / 13.55 oz



Lid for teapot

Couvercle pour théière
Deckel für Teekanne
Tapa para tetera
Coperchio per teiera

NOTPLD2 > **NOTP100**

NOTPLD1 > **NOTP40**



Pieces per box

Pièces par boîte

Stück pro Karton

Piezas por caja

Pezzi per scatola



PIXEL

En

PIXEL displays a relief decoration that is inviting to the touch. Tough and original, its pattern reflects the light for an exquisite dining experience.

Fr

PIXEL affiche un décor en relief qui invite au toucher. Robuste et original, son ornement réfléchit la lumière pour une expérience gustative exquise.

De

Die Serie PIXEL lädt mit ihrem Relief-Dekor förmlich dazu ein, ertastet zu werden. Robust und originell zugleich wirkt sich die Verzierung auf die Lichtwahrnehmung und die geschmackliche Sensorik aus.

Es

PIXEL hace alarde de una decoración en relieve que invita a tocar sus formas. Robusto y original, su ornamentación refleja la luz para crear una experiencia gustativa exquisita.

It

PIXEL sfoggia una decorazione in rilievo che invita al tocco. Robusto e originale, il suo motivo riflette la luce per una squisita esperienza gustativa.





PORCELAIN:
PXCU35 & PXSA17, PXCU09 &
PXSA12, PXTF40, PXFP24



Flat plate

Assiette plate
Teller flach
Plato llano
Piatto piano

PXFP32 32 cm / 12.60"



PXFP29 29 cm / 11.40"

PXFP27 27 cm / 10.65"

PXFP24 24 cm / 9.45"

PXFP21 21 cm / 8.25"



PXFP17 17 cm / 6.70"



Cream soup bowl, 2 handles

Tasse à bouillon, 2 anses
Suppentasse, 2 Henkel
Bol consommé, 2 asas
Scodella per zuppa,
2 manici

PXCS35 11.5 cm - 6.5 cm - 35 cl
4.50" - 2.60" - 11.85 oz



Cream soup bowl

Tasse à bouillon
Suppentasse
Bol consommé
Scodella per zuppa

PXCS01 11.5 cm - 6.5 cm - 35 cl
4.55" - 2.55" - 11.85 oz



Deep plate

Assiette creuse
Teller tief
Plato hondo
Piatto fondo

PXDP28 28 cm / 11"

PXDP24 24 cm / 9.45"



Oval plate

Plat ovale
Platte oval
Fuente oval
Piatto ovale

PXOP36 36 x 27.5 cm / 14.15 x 10.85"

PXOP34 34 x 26 cm / 13.40 x 10.25"



Cup

Tasse
Tasse
Taza
Tazza

PXCU35 35 cl / 11.85 oz

PXCU30 30 cl / 10.15 oz

PXCU27 27 cl / 9.15 oz



Cereal bowl

Bol à céréales
Muesli-Schale
Bol a cereales
Coppetta per cereali

PXBC30 13.5 cm - 5.5 cm - 30 cl
5.30" - 2.15" - 10.15 oz



Saucer

Soucoupe
Untere
Platillo
Piattino

PXSA17 > **PXCU35** / **PXCU30** / **PXCU27** /
PXCS01 / **PXCS35**

17 cm / 6.70"



**Cup**

Tasse
Tasse
Taza
Tazza

PXCU22 22 cl / 7.45 oz

12

**Saucer**

Soucoupe
Untere
Platillo
Piattino

PXSA15 > PXCU22

15 cm / 5.90"

12

**Cup**

Tasse
Tasse
Taza
Tazza

PXCU09 9 cl / 3.05 oz

12

**Saucer**

Soucoupe
Untere
Platillo
Piattino

PXSA12 > PXCU09

12 cm / 4.70"

12

**Teapot & lid**

Théière & couvercle
Teekanne & Deckel
Tetera & tapa
Teiera & coperchio

PXTP40 40 cl / 13.55 oz

4

Lid for teapot

Couvercle pour théière
Deckel für Teekanne
Tapa para tetera
Coperchio per teiera

PXTP40LD

12

**Coffee pot & lid**

Cafetière & couvercle
Kaffeekanne & Deckel
Cafetera & tapa
Caffettiera & coperchio

PXCP35 35 cl / 11.85 oz

4

Lid for coffee pot

Couvercle pour cafetière
Deckel für Kaffeekanne
Tapa para cafetera
Coperchio per caffettiera

PXCPLD

12





Creamer

Crémier
Milchkännchen
Lechera
Bricco da latte

PXCR25 25 cl / 8.45 oz

PXCR15 15 cl / 5.05 oz



Salt shaker

Salière
Salzstreuer
Salero
Saliera

PXSS01



Sugar bowl & lid

Sucrier & couvercle
Zuckerdose & Deckel
Azucarero & tapa
Zuccheriera & coperchio

PXSU25 25 cl / 8.45 oz



Pepper shaker

Poivrier
Pfefferstreuer
Pimentero
Pepiera

PXPS01



Lid for sugar bowl

Couvercle pour sucrier
Deckel für Zuckerdose
Tapa para azucarero
Coperchio per zuccheriera

PXSULD



Candle holder

Bougeoir
Kerzenhalter
Porta velas
Portacandela

PXCH01



Gravy boat

Saucière
Sauciere
Salsera
Salsiera

PXGB28 15 x 8.7 cm - 28 cl

5.95 x 3.45" - 9.45 oz



Toothpick holder

Porte cure-dents
Zahnstocherhalter
Palillero
Portastecchini

PXTH01



Saucer for gravy boat

Soucoupe pour saucière
Untere für Sauciere
Patillo para salsera
Piattino per salsiera

PXST01 > PXGB28

22 x 15.5 cm

8.60 x 6.15"



Egg Cup

Coquetier
Eierbecher
Huevera
Portauovo

PXEG01





Ashtray
Cendrier
Ascher
Cenicero
Portacenere

PXAT01



Flower vase
Vase
Vase
Florero
Vaso

PXFV01 9 cm / 3.55"



Pieces per box
Pièces par boîte
Stück pro Karton
Piezas por caja
Pezzi per scatola



RONDO

En

With exquisite gentle, rounded lines, on dishes and flat plates, RONDO perfectly enhances your culinary creations. A hotel series par excellence!

Fr

Avec d'exquises lignes arrondies tout en douceur, creuses ou plates, RONDO valorise les créations culinaires à merveille. La série hôtelière par excellence!

De

Mit einer dezenten und runden, sanften Liniensprache stellt die Serie RONDO die kulinarischen Kreationen in den Mittelpunkt. Die Hotelserie par excellence!

Es

RONDO, con exquisitas y suaves líneas redondeadas, ahondadas o llanas, valoriza a la perfección las creaciones culinarias. ¡Es la serie hostelera por excelencia!

It

Con squisite linee morbide e arrotondate, i piatti fondi e piani della linea RONDO valorizzano al massimo le vostre creazioni culinarie. La serie per il settore dell'ospitalità per eccellenza!





RONDO



Flat plate

Assiette plate
Teller flach
Plato llano
Piatto piano

BAFP31D7 31 cm / 12.20"



BAFP29D7 29 cm / 11.40"

BAFP27D7 27 cm / 10.65"

BAFP24D7 24 cm / 9.45"



BAFP21D7 21 cm / 8.25"

BAFP19D7 19 cm / 7.50"

BAFP17D7 17 cm / 6.70"

BAFP15D7 15 cm / 5.90"



Cream soup bowl

2 handles

Tasse à bouillon,
2 anses
Suppentasse,
2 Henkel
Bol consommé,
2 asas
Scodella per zuppa,
2 manici

BACS30D7 10.5 cm - 5.5 cm - 30 cl
4.15" - 2.15" - 10.15 oz

BACS18D7 8.5 cm - 5 cm - 18 cl
3.35" - 1.95" - 6.10 oz



Deep plate

Assiette creuse
Teller tief
Plato hondo
Piatto fondo

BADP30D7 30 cm / 11.80"



BADP23D7 23 cm / 9.05"



Saucer

Soucoupe
Untere
Platillo
Piatino

BAST01D7 > BACS30D7
17 cm / 6.70"

BASA15D7 > BACS18D7
15 cm / 5.90"



Oval plate

Plat ovale
Platte oval
Fuente oval
Piatto ovale

BAOP38D7 38 x 26 cm / 14.95 x 10.25"

BAOP32D7 32 x 22 cm / 12.60 x 8.65"



Salad bowl

Saladier
Salatschale
Ensaladera
Insalatiera

BASP20D7 19.5 cm - 8.5 cm - 105 cl
7.70" - 3.35" - 35.50 oz

BASP16D7 16 cm - 7.5 cm - 67 cl
6.30" - 2.95" - 22.65 oz



Stackable salad bowl

Saladier empilable
Salatschale stapelbar
Ensaladera apilable
Insalatiera impilabile

BASB21D7 21 cm - 7.5 cm - 118 cl
8.25" - 2.95" - 39.90 oz

BASB18D7 18 cm - 6.5 cm - 72 cl
7" - 2.55" - 24.65 oz

BASB16D7 16 cm - 7 cm - 60 cl
6.30" - 2.75" - 20.30 oz



**Bowl**

Bol
Schale
Bol
Coppetta

BABW14D7 14 cm - 6.5 cm - 63 cl
5.50" - 2.50" - 21.30 oz

BABW12D7 12 cm - 6.5 cm - 48 cl
4.70" - 2.50" - 16.25 oz

**Stackable cup**

Tasse empilable
Tasse stapelbar
Taza apilable
Tazza impilabile

BACU23D7 23 cl / 7.80 oz

BACU20D7 20 cl / 6.75 oz

BACU18D7 18 cl / 6.10 oz

**Saucer**

Soucoupe
Untere
Platillo
Piattino

**BASA15D7 > BACU23D7 / BACU20D7
BACU18D7**

15 cm / 5.90"

**Stackable cup**

Tasse empilable
Tasse stapelbar
Taza apilable
Tazza impilabile

BACU09D7 9 cl / 3.05 oz

**Saucer**

Soucoupe
Untere
Platillo
Piattino

BASA13D7 > BACU09D7

13 cm / 5.10"

**Coffee pot & lid**

Cafetière & couvercle
Kaffeekanne & Deckel
Cafetera & tapa
Caffettiera & coperchio

BACF70D7 70 cl / 23.65 oz

BACP35D7 35 cl / 11.85 oz

**Lid for coffee pot**

Couvercle pour cafetière
Deckel für Kaffeekanne
Tapa para cafetera
Coperchio per caffettiera

BACPLD2D7 > BACF70D7

BACPLD1D7 > BACP35D7

**Teapot & lid**

Théière & couvercle
Teekanne & Deckel
Tetera & tapa
Teiera & coperchio

BATP80D7 80 cl / 27.05 oz

BATP40D7 40 cl / 13.55 oz

**Lid for teapot**

Couvercle pour théière
Deckel für Teekanne
Tapa para tetera
Coperchio per teiera

BATPLD2D7 > BATP80D7

BATPLD1D7 > BATP40D7



RONDO



Creamer

Crémier
Milchkännchen
Lechera
Bricco da latte

BACR35D7 35 cl / 11.85 oz

BACR25D7 25 cl / 8.45 oz

BACR15D7 15 cl / 5.05 oz



Sugar pack holder

Sucrier pour dosettes
Zuckertütenschale
Azucarero sobres
Portabustine da zucchero

BASH01D7 11 x 7.6 cm - 20 cl
4.45 x 3" - 6.75 oz



Sugar bowl & lid

Sucrier & couvercle
Zuckerdose & Deckel
Azucarero & tapa
Zuccheriera & coperchio

BASU27D7 27 cl / 9.15 oz



Round sugar pack holder

Sucrier rond à sachets
Zuckertütenschale rund
Azucarero sobres redondo
Contenitore rotondo per pacco di zucchero

BASH02D7 8.5 cm - 23 cl
3.35" - 7.80 oz



Lid for sugar bowl

Couvercle pour sucrier
Deckel für Zuckerdose
Tapa para azucarero
Coperchio per zuccheriera

BASULDD7



Egg cup

Coquetier
Eierbecher
Huevera
Portauovo

BAEG01D7



Salt shaker

Salière
Salzstreuer
Salero
Saliera

BASS01D7



Flower vase

Vase
Vase
Florero
Vaso

BAFV01D7 15.5 cm / 6.10"



Pepper shaker

Poivrier
Pfefferstreuer
Pimentero
Pepiera

BAPS01D7



**Toothpick holder**

Porte cure-dents
Zahnstocherhalter
Palillero
Portastecchini

BATH01D7 5,5 cm / 2,15"

 12

**Ashtray**

Cendrier
Ascher
Cenicero
Portacenere

BAAT01D7 10,5 cm / 4,15"

 12

 Pieces per box
Pièces par boîte
Stück pro Karton
Piezas por caja
Pezzi per scatola



SAMBA

En

The warm fade-resistant colours and elegant design of the SAMBA series enhance the presentation of buffets and breakfasts. SAMBA creates a harmonious and refreshing décor.

Fr

Les chaudes couleurs inaltérables et le design élégant de la série SAMBA rehaussent la présentation des buffets et petits-déjeuners. SAMBA construit un décor harmonieux et rafraîchissant.

De

Mit seinem warmen farbechten Farbtönen ist das elegante Design der Serie SAMBA ein Gewinn für Buffets und Frühstückstische. SAMBA bildet ein harmonisches und frisches Dekor.

Es

Los inalterables colores cálidos y el elegante diseño de la serie SAMBA realzan la presentación de bufés y desayunos. SAMBA crea una decoración armoniosa y refrescante.

It

I colori caldi e inalterabili e il design elegante della serie SAMBA mettono in risalto la presentazione dei cibi preparati per buffet e colazioni. SAMBA conferisce un tocco armonioso e rinfrescante.





SAMBA



Noodle Bowl

Bol à nouilles
Nudelschale
Noodle Bol
Coppetta per pasta

15 cm - 6 cm - 63 cl
5.90" - 2.35" - 21.30 oz



- OPNB15PD1
- OPNB15PD3
- OPNB15PD4
- OPNB15PD5



Chilli bowl

Bol Chilli
Schale Chilli
Bol Chilli
Coppetta Chilli

7.5 cm - 6 cm - 18 cl
2.95" - 2.35" - 6.10 oz



- SPCU18PD1
- SPCU18PD3
- SPCU18PD4
- SPCU18PD5



Round bowl

Bol rond
Schale rund
Bol redondo
Coppetta rotonda

14 cm - 6.5 cm - 45 cl
5.50" - 2.55" - 15.20 oz



- FDBI14PD1
- FDBI14PD3
- FDBI14PD4
- FDBI14PD5



12 cm - 6 cm - 28 cl
4.70" - 2.35" - 9.45 oz



- FDBI12PD1
- FDBI12PD3
- FDBI12PD4
- FDBI12PD5

11 cm - 5 cm - 22 cl
4.35" - 1.95" - 7.45 oz



- FDBI11PD1
- FDBI11PD3
- FDBI11PD4
- FDBI11PD5



Flora mug

Chope Flora
Becher Flora
Mug Flora
Mug Flora

36 cl - 12.15 oz



- BAFMG36PD1
- BAFMG36PD3
- BAFMG36PD4
- BAFMG36PD5
- > BAST01



30 cl - 10.15 oz



- BAFMG30PD1
- BAFMG30PD3
- BAFMG30PD4
- BAFMG30PD5
- > CLSA01

26 cl - 8.80 oz



- BAMG26PD1
- BAMG26PD3
- BAMG26PD4
- BAMG26PD5
- > CLSA01



Pieces per box
Pièces par boîte
Stück pro Karton
Piezas por caja
Pezzi per scatola



Non-stackable cup
Tasse non empilabile
Tasse nicht stapelbar
Taza no apilable
Tazza non impilabile

28 cl - 9.45 oz

- BANC28PD1
- BANC28PD3
- BANC28PD4
- BANC28PD5
- > BAST01

 12



22 cl - 7.45 oz

- BANC22PD1
- BANC22PD3
- BANC22PD4
- BANC22PD5
- > BASA15

 12



15 cl - 5.05 oz

 12

- BANC15PD1
- BANC15PD3
- BANC15PD4
- BANC15PD5
- > BASA15



9 cl - 3.05 oz

 12

- BANC09PD1
- BANC09PD3
- BANC09PD4
- BANC09PD5
- > BASA13



SKA

En

The round and square shapes of the SKA product line offer a perfect platform for a number of culinary uses. Specifically created to be used in mass and commercial catering, the SKA product line has a toughness you can rely on and is very stackable.

Fr

Les formes rondes et carrées de la gamme SKA forment un support parfait pour des utilisations culinaires multiples. Réalisée pour un usage en restauration collective et commerciale, la gamme SKA est dotée d'une solidité à toute épreuve, empilable à loisir.

De

Die runden und eckigen Formen der Serie SKA sind die ideale Grundlage für vielfältige gastronomische Einsatzmöglichkeiten. Die Serie SKA ist für den Einsatz in der Großgastronomie konzipiert und besonders bruchfest sowie hervorragend stapelbar.

Es

Las formas redondas y cuadradas de la gama SKA forman un soporte perfecto para múltiples usos culinarios. La gama SKA, creada para su uso en restauración colectiva y comercial, está dotada de una solidez a toda prueba, apilable tanto como se quiera.

It

Le forme rotonde e quadrate della gamma SKA offrono un supporto perfetto per molteplici utilizzi culinari. Realizzata per essere impiegata nella ristorazione collettiva e commerciale, la serie SKA vanta pezzi dalla solidità eccezionale e impilabili a piacimento.







Square flat plate
Assiette plate carrée
Teller flach quadratisch
Plato llano cuadrado
Piatto piano quadrato

SKSFP31 31 cm / 12.20"



SKSFP27 27 cm / 10.65"

SKSFP24 24 cm / 9.45"

SKSFP21 21 cm / 8.25"



SKSFP19 19 cm / 7.50"

SKSFP17 17 cm / 6.70"

SKSFP14 14 cm / 5.50"



Round narrow rim deep plate
Assiette creuse ronde coupe
Teller tief rund coupe
Plato hondo redondo coupe
Piatto fondo rotondo senza falda

SKRDP26 26 cm / 10.25"

SKRDP22 22 cm / 8.65"



Steak platter
Plat à entrecôte
Steak Platte
Fuente steak
Piatto per bistecca

SKRP30 30 x 20 cm / 11.80 x 7.85"



Square deep plate
Assiette creuse carrée
Teller tief quadratisch
Plato hondo cuadrado
Piatto fondo quadrato

SKSDP27 27 cm / 10.65"

SKSDP24 24 cm / 9.45"

SKSDP21 21 cm / 8.25"



SKSDP15 15 cm / 5.90"

SKSDP14 14 cm / 5.50"



Round bowl
Bol rond
Schale rund
Bol redondo
Coppetta rotonda

SKBWL23 23 cm - 6 cm - 100 cl
9.05" - 2.35" - 33.80 oz



SKBWL17 17 cm - 5 cm - 45 cl
6.70" - 1.95" - 15.20 oz



Round narrow rim flat plate
Assiette plate ronde coupe
Teller flach rund coupe
Plato llano redondo coupe
Piatto piano rotondo senza falda

SKRFP28 28 cm / 11"

SKRFP24 24 cm / 9.45"

SKRFP22 22 cm / 8.65"



SKRFP19 19 cm / 7.50"

SKRFP16 16 cm / 6.30"



Square-round dish
Ravier rond-carré
Schale rund quadratisch
Bol cuadrado redondo
Coppetta rotonda-quadrata

SKSRD16 16 cm - 30 cl
6.30" - 10.15 oz

SKSRD14 14 cm - 25 cl
5.50" - 8.45 oz

SKSRD12 12 cm - 18 cl
4.70" - 6.10 oz

SKSRD11 11 cm - 10 cl
4.35" - 3.40 oz

SKSRD10 10 cm - 7.5 cl
3.95" - 2.55 oz





Rectangular dish
Ravier rectangulaire
Schale rechteckig
Rabanera rectangular
Coppetta rettangolare

SKRTD15 15 x 10 cm - 3.5 cm
5.90 x 3.95" - 1.40"

12



Square dish
Ravier carré
Schale quadratisch
Rabanera cuadrada
Coppetta quadrata

SKSTD11 11 cm - 3.4 cm
4.35" - 1.35"

12



Stackable bowl
Bol empilable
Schale stapelbar
Bol apilable
Coppetta impilabile

SKBWL60 15 cm - 6 cm - 60 cl
5.90" - 2.35" - 20.30 oz

SKBWL40 13 cm - 5.5 cm - 40 cl
5.10" - 2.15" - 13.55 oz

12



**Cream soup bowl,
2 handles**
Tasse à bouillon, 2 anses
Suppentasse, 2 Henkel
Bol consommé, 2 asas
Scodella per zuppa,
2 manici

SKCS30 10 cm - 6 cm - 30 cl
3.95" - 2.35" - 10.15 oz

12



Breakfast cup
Tasse à déjeuner
Frühstückstasse
Taza de desayuno
Tazza da colazione

SKCU30 30 cl / 10.15 oz

12



**Saucer for breakfast cup
& cream soup bowl**
Soucoupe pour tasse à
déjeuner & tasse à bouillon
Untere für Frühstückstasse
& Suppentasse
Platillo para taza de
desayuno & bol consommé
Piatino per tazza da
colazione e Scodella per
zuppa

SKSA16 > SKCU30 / SKCS30
16 cm / 6.30"

12



Coffee/tea cup
Tasse à café/thé
Kaffee/Teetasse
Taza a café/té
Tazza da caffè/tè

SKCU23 23 cl / 7.80 oz

SKCU17 17 cl / 5.75 oz

12



Cup without handle
Tasse sans anse
Tasse ohne Henkel
Taza sin aza
Tazza senza manici

SKCU17M 17 cl / 5.75 oz

12





Saucer for tea/coffee cup
 Soucoupe pour tasse à thé/café
 Untere für Tee/Kaffeetasse
 Platillo para taza a té/café
 Piattino per tazza da caffè/tè

SKSA14 > SKCU23 / SKCU17
 / SKCU17M

14 cm / 5.50"



Espresso Cup
 Tasse à expresso
 Espressotasse
 Taza a expreso
 Tazza da espresso

SKCU09 9 cl / 3.05 oz



Saucer for espresso cup
 Soucoupe pour tasse à expresso
 Untere für Espressotasse
 Platillo para taza a expreso
 Piattino per tazza da espresso

SKSA12 > SKCU09

12 cm / 4.70"



Mug
 Chope
 Becher
 Mug
 Mug

SKSM30 30 cl / 10.15 oz



Mug
 Chope
 Becher
 Mug
 Mug

SKMG22 22 cl / 7.45 oz



Mug Orchid

Chope Orchid
 Becher Orchid
 Mug Orchid
 Mug Orchid

SKMG33 33 cl / 11.15 oz



Coffee pot & lid

Cafetière & couvercle
 Kaffeekanne & Deckel
 Cafetera & tapa
 Caffettiera & coperchio

SKCP70 70 cl / 23.65 oz

SKCP35 35 cl / 11.85 oz



Lid for coffee pot

Couvercle pour cafetière
 Deckel für Kaffeekanne
 Tapa para cafetera
 Coperchio per caffettiera

SKCPLD2 > SKCP70

SKCPLD > SKCP35



Teapot & lid

Théière & couvercle
 Teekanne & Deckel
 Tetera & tapa
 Teiera & coperchio

SKTP80 80 cl / 27.05 oz

SKTP40 40 cl / 13.55 oz



Lid for teapot

Couvercle pour théière
 Deckel für Teekanne
 Tapa para tetera
 Coperchio per teiera

SKTPLD2 > SKTP80

SKTPLD > SKTP40



Creamer

Crémier
 Milchkönnchen
 Lechera
 Bricco da latte

SKCR15 15 cl / 5.05 oz





Small creamer
 Petit crémier
 Milchkännchen
 Lechera pequeña
 Bricco da latte piccolo

103JG02 2 cl / 0.70 oz



Sugar holder
 Sucrier
 Zuckerdose
 Azucarero
 Zuccheriera

SKSH23 23 cl / 7.80 oz



Sugar bowl & lid
 Sucrier & couvercle
 Zuckerdose & Deckel
 Azucarero & tapa
 Zuccheriera & coperchio

SKSU25 25 cl / 8.45 oz



Pepper shaker
 Poivrier
 Pfefferstreuer
 Pimentero
 Pepiera

SKPS01 6.5 cm / 2.55"



Salt shaker
 Salière
 Salzstreuer
 Salero
 Saliera

SKSS01 6.5 cm / 2.55"



Toothpick holder
 Porte cure-dents
 Zahnstocherhalter
 Palillero
 Portastecchini

SKTH01 6 cm / 2.35"



 Pieces per box
 Pièces par boîte
 Stück pro Karton
 Piezas por caja
 Pezzi per scatola

SUPREME **NEW**

En

Set against a shine-matte duo, SUPREME offers a touch of velvet and a brilliant contrast, ideal for uplifting culinary scenes.

Fr

Basée sur l'expression lumineuse d'un duo brillance-matité, SUPREME offre un toucher de velours et un contraste éclatant idéal pour élever les scènes culinaires.

De

Basierend auf dem leuchtenden Ausdruck einer Kombination aus Glanz und Mattheit bietet SUPREME einen samtigen Touch und einen hellen Kontrast, der ideal ist, um kulinarische Szenarien zu bereichern.

Es

Basada en la expresión luminosa de un dúo brillo-matidez, SUPREME ofrece un tacto de terciopelo y un contraste radiante ideal para elevar los escenarios culinarios.

It

Basato sull'espressione luminosa di un duo brillantezza-opacità, SUPREME offre una sensazione vellutata e un contrasto eclatante ideale per elevare le varietà culinarie.

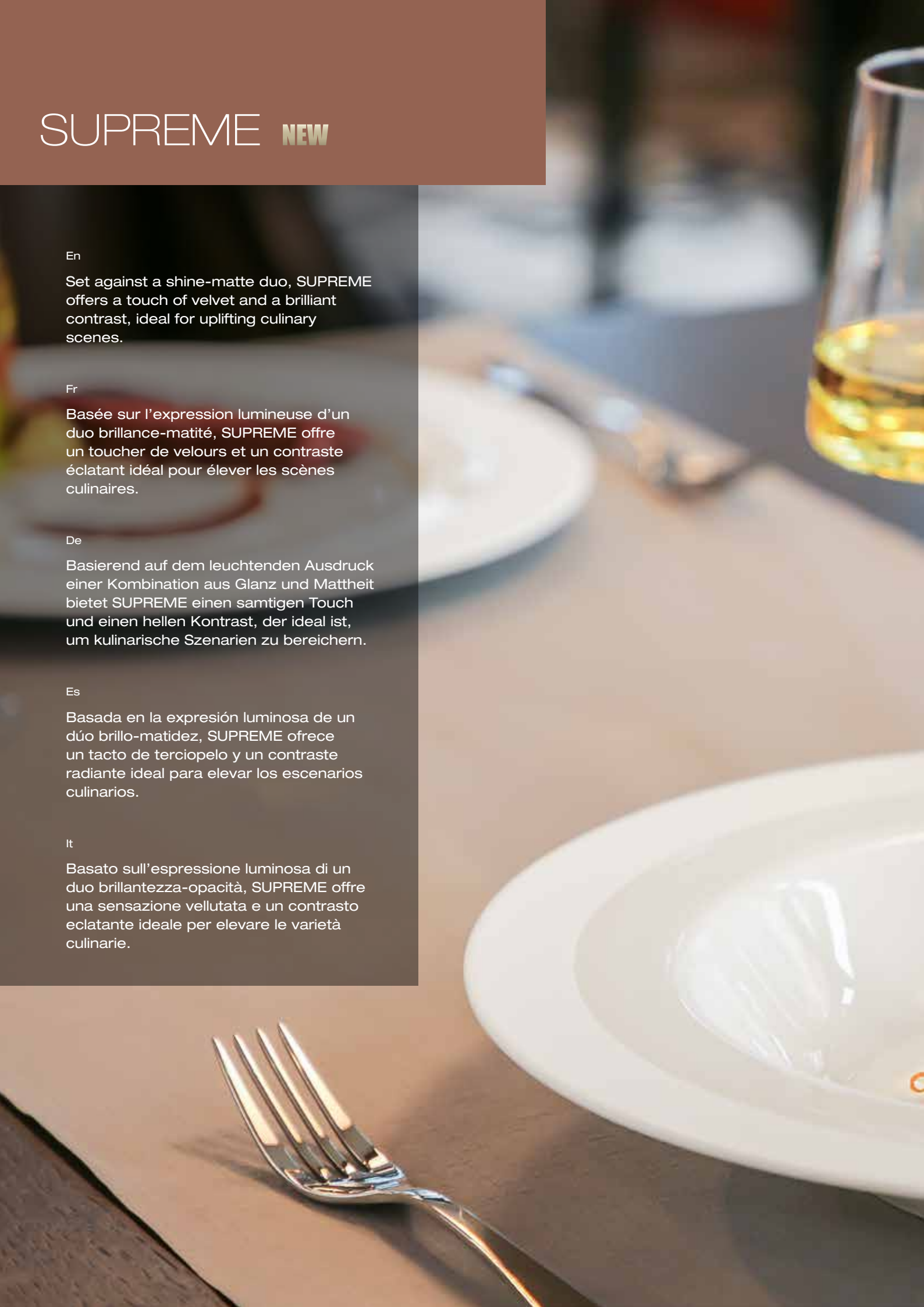



SUPREME **NEW**



Flat plate

Assiette plate
Teller flach
Plato llano
Piatto piano

SUFP33 33 cm / 13"

SUFP31 31 cm / 12.20"



SUFP29 29 cm / 11.40"

SUFP27 27 cm / 10.65"

SUFP25 25 cm / 9.85"

SUFP22 22 cm / 8.65"



SUFP16 16 cm / 6.30"



Coffee cup

Tasse à café
Kaffeetasse
Taza a café
Tazza da caffè

SUCU23 23 cl / 7.80 oz



Saucer for coffee cup

Soucoupe pour tasse à café
Untere für Kaffeetasse
Platillo para taza a café
Piattino per tazza da caffè

SUSA15 > SUCU23

15 cm / 5.90"



Deep plate

Assiette creuse
Teller tief
Plato hondo
Piatto fondo

SUDP31 31 cm / 12.20"



SUDP23 23 cm / 9.05"



Espresso cup

Tasse à expresso
Espressotasse
Taza a expreso
Tazza da espresso

SUCU09 9 cl / 3.05 oz



Gourmet flat plate

Assiette plate gourmet
Gourmetteller flach
Plato llano gourmet
Piatto piano gourmet

SUGF29 29 cm / 11.40"



Saucer for espresso cup

Soucoupe pour tasse à expresso
Untere für Espressotasse
Platillo para taza a expreso
Piattino per tazza da espresso

SUSA13 > SUCU09

13 cm / 5.10"



Deep plate

Assiette creuse
Teller tief
Plato hondo
Piatto fondo

SUGDDP29 29 cm / 11.40"

SUGDDP26 26 cm / 10.25"

SUGDDP23 23 cm / 9.05"



 Pieces per box
Pièces par boîte
Stück pro Karton
Piezas por caja
Pezzi per scatola



WHITE GOLD

En

The grace of its baroque curves gives WHITE GOLD a princely appeal. Carved like lacework, this series delicately presents your culinary showpieces, from the simplest ones to the most sophisticated.

Fr

Avec la grâce de ses courbes baroques, WHITE GOLD arbore une allure princière. Ciselée comme de la dentelle, cette série présente avec délicatesse les œuvres culinaires des plus simples aux plus recherchées.

De

Mit der barocken Linienführung strahlt die Serie WHITE GOLD eine fürstliche Anmut aus. Ziseliert wie feinste Spitze präsentiert diese Serie mit Zartheit kulinarische Werke von ganz schlichter bis höchst komplexer Art.

Es

WHITE GOLD, con la gracia de sus curvas barrocas, hace gala de un aspecto principesco. Esta serie, tallada como si fuera de encaje, presenta con delicadez las más sencillas y solicitadas obras culinarias.

It

Con la grazia delle sue curve barocche, la linea WHITE GOLD sfoggia un fascino principesco. Cesellata in maniera tale da richiamare alle mente pizzi e merletti, questa serie presenta con delicatezza le opere culinarie più semplici e quelle più ricercate.





WHITE GOLD



KING

Serving tray rectangular

Plat rectangulaire
Platte rechteckig
Bandeja servicio rectangular
Vassoio da portata rettangolare

GDRT42 42 x 32,5 cm
16.55 x 12.80"



PRINCE

Deep plate

Assiette creuse
Teller tief
Plato hondo
Piatto fondo

GDDP29 29 cm / 11.40"
GDDP23 23 cm / 9.05"



Square plate

Assiette carrée
Teller quadratisch
Plato cuadrado
Piatto quadrato

GDSP34 34 cm / 13.40"



GDSP26 26 cm / 10.25"



PRINCESS

Scallop plate

Assiette festonnée
Teller festoniert
Plato scallop
Piatto smerlato

GDSP33 33 cm / 13"



QUEEN

Round plate

Assiette ronde
Teller rund
Plato redondo
Piatto rotondo

GDRP31 31 cm / 12.20"

GDRP28G 28 cm / 11"



Soup tureen & lid

Soupière & couvercle
Suppenterrine & Deckel
Sopera & tapa
Zuppiera & coperchio

GDSB340 340 cl / 114.95 oz



Lid for soup bowl tureen

Couvercle pour soupière
Deckel für Suppenterrine
Tapa para sopra
Coperchio per zuppiera

GDSBLD



Round plate

Assiette ronde
Teller rund
Plato redondo
Piatto rotondo

GDRP28 28 cm / 11"



GDRP22 22 cm / 8.65"



GDRP16 16 cm / 6.30"



**Tea cup**

Tasse à thé
Teetasse
Taza a té
Tazza da tè

GDCU21 21 cl / 7.10 oz

**Espresso cup**

Tasse à expresso
Espressotasse
Taza a expreso
Tazza da espresso

GDCU09 9 cl / 3.05 oz

**Bowl**

Bol
Schale
Bol
Copetta

GDCU21M 21 cl / 7.10 oz

**Bowl**

Bol
Schale
Bol
Copetta

GDCU09M 9 cl / 3.05 oz

**Saucer**

Soucoupe
Untere
Platillo
Piattino

GDSA15 > GDCU21M / GDCU21

15 cm / 5.90"

**Saucer**

Soucoupe
Untere
Platillo
Piattino

GDSA12 > GDCU09M / GDCU09

12 cm / 4.70"



WHITE GOLD



Coffee pot & lid

Cafetière & couvercle
Kaffeekanne & Deckel
Cafetera & tapa
Caffettiera & coperchio

GDCP160 160 cl / 54.10 oz



Creamer

Crémier
Milchkännchen
Lechera
Bricco da latte

GDCR25 25 cl / 8.45 oz



Lid for coffee pot

Couvercle pour cafetière
Deckel für Kaffeekanne
Tapa para cafetera
Coperchio per caffettiera

GDCPLD



Sugar bowl & lid

Sucrier & couvercle
Zuckerdose & Deckel
Azucarero & tapa
Zuccheriera & coperchio

GDSU25 25 cl / 8.45 oz



Teapot & lid

Théière & couvercle
Teekanne & Deckel
Tetera & tapa
Teiera & coperchio

GDTP150 150 cl / 50.70 oz



Lid for sugar bowl

Couvercle pour sucrier
Deckel für Zuckerdose
Tapa para azucarero
Coperchio per zuccheriera

GDSULD



Lid for teapot

Couvercle pour théière
Deckel für Teekanne
Tapa para tetera
Coperchio per teiera

GDTPLD





WONDER **NEW**

En

The contemporary decoration with a subtle relief provides an alternative and unconventional look.

Fr

Le décor contemporain et en subtil relief offre une alternative et un look décalés.

De

Das moderne Dekor mit feinem Relief bietet eine willkommene Alternative und einen unkonventionellen Look.

Es

La decoración contemporánea en un sutil relieve ofrece una alternativa y un look originales.

It

La decorazione in stile contemporaneo e il delicato rilievo si caratterizzano per il loro aspetto insolito e creativo.







Round flat plate

Assiette plate ronde
Teller flach rund
Plato llano redondo
Piatto piano rotondo

CLFP31D181 31 cm / 12.20"



CLFP29D181 29 cm / 11.40"

CLFP28D181 28 cm / 11"

CLFP27D181 27 cm / 10.65"

CLFP24D181 24 cm / 9.45"



CLFP21D181 21 cm / 8.25"

CLFP19D181 19 cm / 7.50"

CLFP17D181 17 cm / 6.70"

CLFP15D181 15 cm / 5.90"



Non stackable cup

Tasse non empilable
Tasse nicht stapelbar
Taza no apilable
Tazza non impilabile

CLCU28D181 28 cl / 9.45 oz

CLCU23D181 23 cl / 7.80 oz

CLCU20D181 20 cl / 6.75 oz

CLCU09D181 9 cl / 3.05 oz



Stackable cup

Tasse empilable
Tasse stapelbar
Taza apilable
Tazza impilabile

CLSC23D181 23 cl / 7.80 oz

CLSC20D181 20 cl / 6.75 oz

CLSC09D181 9 cl / 3.05 oz



Saucer for cup

Soucoupe pour tasse
Untere für Tasse
Platillo para taza
Piattino per tazza

CLSA17D181 > **CLCU28D181**

17 cm / 6.70"

CLSA15D181 > **CLCU23D181** / **CLSC23D181** /
CLCU20D181 / **CLSC20D181**

15 cm / 5.90"

CLSA13D181 > **CLCU09D181** / **CLSC09D181**

13 cm / 5.10"



Round deep plate

Assiette creuse ronde
Teller tief rund
Plato hondo redondo
Piatto fondo rotondo

CLDP30D181 30 cm / 11.80"



CLDP26D181 26 cm / 10.25"

CLDP24D181 24 cm / 9.45"

CLDP19D181 19 cm / 7.55"



Extra deep round plate

Assiette extra creuse ronde
Teller extra tief rund
Plato extra hondo redondo
Piatto extra fondo rotondo

CLXD26D181 26 cm - 48 cl
10.25" - 16.25 oz

CLXD23D181 23 cm - 32 cl
9.05" - 10.80 oz





SMALL AND SMART

En

On the following pages you will find a selection of items designed specifically for mini portions. Even the most minimalist of presentations are stunningly displayed on these miniature pieces.

Fr

Retrouvez sur ces pages une sélection d'articles particulièrement adaptés aux mini-portions. Ces pièces miniatures mettent brillamment en scène les présentations même les plus minimalistes.

De

Auf den nächsten Seiten finden Sie eine Auswahl an Artikeln, die sich ganz besonders für sehr kleine Portionen eignen. Diese Miniaturteile setzen selbst die minimalistischsten Speisen wirkungsvoll in Szene.

Es

En estas páginas encontrará una selección de artículos especialmente adaptados a las minirraciones. Estas piezas miniaturas ponen perfectamente en escena las presentaciones más minimalistas.

It

Ritrovate su queste pagine una selezione di articoli particolarmente adatti alle mini porzioni. Questi pezzi in miniatura mettono in scena in modo particolarmente brillante le scenografie più minimaliste modernità e robustezza.

ALLSPICE



Round bowl

Bol rond
Schale rund
Bol redondo
Coppetta rotonda

SPCB32 14 cm - 3.5 cm - 32 cl
5.50" - 1.40" - 10.80 oz

SPCB20 11 cm - 3.5 cm - 20 cl
4.35" - 1.40" - 6.75 oz

SPCB11 8 cm - 3.5 cm - 11 cl
3.15" - 1.40" - 3.70 oz



Cup without handle

Tasse sans anse
Tasse ohne Henkel
Taza sin asa
Tazza senza manici

SPCU09 9 cl / 3.05 oz

SPCU07 7 cl / 2.35 oz



Bowl

Bol
Schale
Bol
Coppetta

SPCU18 7.5 cm - 6 cm - 18 cl
2.95" - 2.35" - 6 oz



**Oval flat plate**

Assiette plate ovale
Teller flach oval
Plato llano oval
Piatto piano ovale

SPEG19 19 x 16 cm / 7.50 x 6.30"

12

**Oval plate, 1 rectangular indent**

Plat ovale, 1 encoche rectangulaire
Platte oval, 1 rechteckige Fläche
Fuente oval, 1 estanque rectangular
Piatto ovale, 1 inserto rettangolare

SPTM30 30 x 12 cm
11.80 x 4.70"

6

**Square plate, 1 rectangular indent**

Assiette carrée, 1 encoche
rectangulaire
Teller quadratisch, 1 rechteckige
Fläche
Plato cuadrado, 1 estanque
rectangular
Piatto quadrato, 1 inserto rettangolare

SPDP19 19 cm / 7.50"

12

**Oval flat plate**

Assiette plate ovale
Teller flach oval
Plato llano oval
Piatto piano ovale

SPEY19 19 x 14 cm / 7.50 x 5.50"

12

SMALL AND SMART

BANQUET



Cream soup bowl, 2 handles

Tasse à bouillon, 2 anses
Suppentasse, 2 Henkel
Bol consommé, 2 asas
Scodella per zuppa, 2 manici

BACS18 8.5 cm - 5 cm - 18 cl
3.35" - 1.95" - 6.10 oz



Ristretto cup

Tasse ristretto
RistrettoTasse
Taza ristretto
Tazza ristretto

BANC07 7 cl / 2.35 oz



Salad bowl

Saladier
Salatschale
Ensaladera
Insalatiera

BASP12 12 cm - 6 cm - 31 cl
4.70" - 2.35" - 10.50 oz



Stackable butter ramekin

Ramequin à beurre empilable
Butterschälchen stapelbar
Platillo para mantequilla apilable
Coppetta da burro impilabile

BABR03 7 cm - 3 cm - 6 cl
2.75" - 1.20" - 2.05 oz



Large mezza bowl

Grand bol mezza
Mezza Schale groß
Bol mezza grande
Coppetta mezza grande

BAMB17 17 cm - 4 cm - 36 cl
6.70" - 1.55" - 12.15 oz



Stackable butter ramekin

Ramequin à beurre empilable
Butterschälchen stapelbar
Platillo para mantequilla apilable
Coppetta da burro impilabile

BABR02 8 cm - 3.5 cm - 10 cl
3.15" - 1.40" - 3.40 oz



Small mezza bowl

Petit bol mezza
Mezza Schale klein
Bol mezza pequeño
Coppetta mezza piccola

BAMB13 13 cm - 4 cm - 17 cl
5.10" - 1.55" - 5.75 oz



**Butter ramekin**

Ramequin à beurre
Butterschälchen
Platillo para mantequilla
Coppetta da burro

BABR01 6.7 cm - 6 cl / 2.65" - 2.05 oz

**Continental sauce dish**

Plat à sauce continental
Saucenschale kontinental
Salsiera continental
Salsiera continentale

BACD09 9 x 7 cm / 3.55 x 2.75"

**Butter dish**

Assiette à beurre
Butterteller
Plato mantequilla
Piatto da burro

BABD11 11 x 8 cm / 4.35 x 3.15"

**Flower dish**

Coupelle fleur
Schale in Blumenform
Concha flor
Coppetta fiore

BAFD01 9 cm - 15 cl
3.55" - 5.05 oz

**Egg cup**

Coquetier
Eierbecher
Huevera
Portauovo

BAEG01

**Toothpick holder**

Porte cure-dents
Zahnstocherhalter
Palillero
Portastecchini

BATH01 7 cl / 2.35 oz



SMALL AND SMART

FINE DINE



Oval salad bowl
Saladier ovale
Salatschale oval
Ensaladera oval
Insalatiera ovale

FDBO16 16 x 11 cm - 5 cm
6.30 x 4.35" - 1.95"



Round bowl
Bol rond
Schale rund
Bol redondo
Coppetta rotonda

FDBI08 8 cm - 4 cm - 11 cl
3.15" - 1.55" - 3.70 oz



MASSILIA



Coffee/tea cup without handle
Tasse à café/thé sans anse
Kaffee-/Teetasse ohne Henkel
Taza a café/té sin asa
Tazza da caffè/tè senza manici

MSCU17M 8 cm - 17 cl
3.15" - 5.75 oz



Espresso cup without handle
Tasse à expresso sans anse
Espressotasse ohne Henkel
Taza a expreso sin asa
Tazza da espresso senza manici

MSCU10M 6 cm - 11 cl
2.35" - 3.70 oz



MAZZA



Cocktail plate
Assiette cocktail
Cocktailteller
Plato cóctel
Piatto cocktail

MZCP32 32 x 9.5 cm
12.60 x 3.75"

MZCP26 26 x 7.5 cm
10.25 x 3"

MZCP20 20 x 6.5 cm
7.85 x 2.50"



Mini square dish
Coupelle carrée
Schale quadratisch
Rabanera mini quadrada
Mini coppetta quadrata

MZMS08 8 x 7.5 cm
3.15 x 2.95"



Mini rectangular dish
Coupelle rectangulaire
Schale rechteckig
Rabanera mini rectangular
Mini coppetta rettangolare

MZMR11 11 x 5.5 cm
4.35 x 2.15"



SMALL AND SMART

MINIMAX

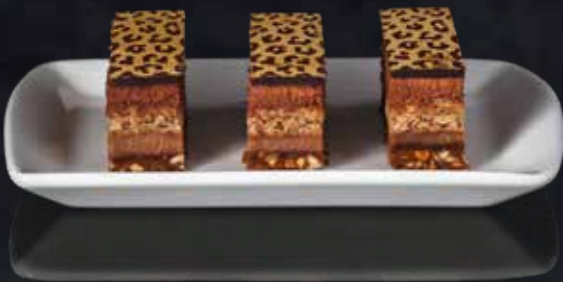

Sandwich tray
 Plat à sandwich
 Sandwichplatte
 Bandeja sándwich
 Vassoio sandwich
OPSP14 14 x 8 cm
 5.50 x 3.15"
 12



Soup spoon
 Cuillère à soupe
 Suppenlöffel
 Cuchara de sopa
 Cucchiaino da tavola
ACSP01 12 cm / 4.70"
 24

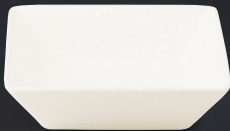

Square bowl
 Bol carré
 Schale quadratisch
 Bol cuadrado
 Coppetta quadrata
OPSB09 9 cm - 5 cm - 17 cl
 3.55" - 1.95" - 5.75 oz
 6

OPSB08 8 cm - 4 cm - 10.5 cl
 3.15" - 1.55" - 3.55 oz

 12

OPSB07 7 cm - 3.5 cm - 7 cl
 2.75" - 1.40" - 2.35 oz

 6

OPSB04 4 cm - 2 cm - 2 cl
 1.55" - 0.80" - 0.70 oz

 24



High cube
 Cube haut
 Kubus hoch
 Cubo alto
 Coppetta a cubo alta
OPSD01 5 cm - 5.5 cm - 9 cl
 1.95" - 2.15" - 3.05 oz
 12



Small cube
 Cube bas
 Kubus klein
 Cubo bajo
 Coppetta a cubo piccola
OPSD02 5 cm - 4.5 cm - 6 cl
 1.95" - 1.75" - 2.05 oz
 12



Yin Yang saucer
 Yin Yang saucière
 Yin Yang Sauciere
 Salsera Yin Yang
 Salsiera Yin Yang
ACYY01 10 cm / 3.95"
 24



Square creamer/gravy boat
 Crémier/saucière carré
 Saucière/Milchkännchen quadratisch
 Salsera/lechera cuadrada
 Salsiera/bricco da latte quadrato
OPSD03 5 cm - 6 cm - 8 cl
 1.95" - 2.30" - 2.70 oz
 12



Mini pan with grip
Mini poêlon avec poignée
Mini Pfanne mit Griff
Mini sartén con asa
Mini tegame

MNMP01 6.2 cm / 2.45"



Asymmetric dish
Coupelle asymétrique
Schale asymmetrisch
Bol asimétrico
Coppetta asimmetrica

OPAB06 6 cm - 2 cm
2.35" - 0.80"



Square sauce dish
Bol à sauce carré
Saucenschale quadratisch
Bol salsa cuadrado
Salsiera quadrata

ACSD01 7.5 cm - 3 cm
2.95" - 1.20"



Miniature round bowl
Miniature bol rond
Miniaturschale rund
Miniatura bol redondo
Miniatura coppetta rotonda

OPCU05 5 cl / 1.70 oz



Rectangular twin sauce bowl
Coupelle à sauce double
Doppelte Saucenschale rechteckig
Bol salsa doble rectangular
Coppetta per salsa doppia rettangolare

ACTS01 14.5 x 7 cm - 3 cm
5.70 x 2.75" - 1.20"



Egg cup
Coquetier
Eierbecher
Huevera
Portauovo

OPEG01



SMALL AND SMART

MINIMAX



Mini boat bowl

Mini bol bateau
Mini Bootschale
Mini bol barco
Mini coppetta barca

MNOD05 7.3 x 4.5 cm - 3 cm - 3 cl
2.85" x 1.75" - 1.20" - 1 oz



Bowl

Bol
Schale
Bol
Coppetta

NAMB16 16 cm - 3.5 cm - 12 cl
6.30" - 1.40" - 4.05 oz



Round bowl Katori

Bol rond Katori
Schale rund Katori
Bol redondo Katori
Coppetta rotonda Katori

MNRD10 10 cm - 4.5 cm - 18 cl
3.95" - 1.75" - 6.10 oz



Triangular bowl

Bol triangulaire
Schale dreieckig
Bol triangular
Coppetta triangolare

OPTB12 12 cm - 25.5 cl / 4.70" - 8.60 oz
OPTB10 10 cm - 15.5 cl / 4" - 5.25 oz



NABUR



Party plate
Assiette cocktail
Cocktailteller
Plato cóctel
Piatto cocktail

NBPP22 22 x 15.5 cm
8.65 x 6.10"



NANO



Butter dish
Assiette à beurre
Butterschale
Plato mantequilla
Piatto da burro

NNBD09 9 cm / 3.55"
NNBD07 7 cm / 2.75"



Dip bowl
Coupelle
Schälchen
Bol hondo
Coppetta

NBDB08 8 x 6.5 cm - 2 cm - 4 cl
3.15 x 2.55" - 0.80" - 1.35 oz



Non stackable bowl
Bol non empilable
Schale nicht stapelbar
Bol no apilable
Coppetta non impilabile

NNBW10 10 cm - 5 cm - 16 cl
3.95" - 1.95" - 5.40 oz

NNBW09 9 cm - 4 cm - 11 cl
3.55" - 1.55" - 3.70 oz



Spoon
Cuillère
Löffel
Cuchara
Cucchiaio

NNSP14 14 cm / 5.50"



SMALL AND SMART

NORDIC



Mise en bouche/cup
Mise en bouche/tasse
Mise en bouche/Tasse
Mise en bouche/taza
Mise en bouche/tazza

NOMB1 9 cl / 3.05 oz

 12



Saucer for Breakfast/tea cup
Soucoupe pour tasse à déjeuner/thé
Untere für Frühstücks/Teetasse
Platillo para taza a desayuno/té
Piattino per tazza da colazione/té

NOSA3 > NOCU30

15.5 cm / 6.10"

 6



Saucer for coffee cup
Soucoupe pour tasse à café
Untere für Kaffeetasse
Platillo para taza a café
Piattino per tazza da caffè

NOSA2 > NOCU20

14 cm / 5.50"

 6



Saucer for espresso cup
Soucoupe pour tasse à espresso
Untere für Espressotasse
Platillo para taza a espresso
Piattino per tazza da espresso

NOSA1 > NOCU09

10 cm / 3.95"

 12

SKA



Square-round dish

Ravier rond-carré
Schale rund quadratisch
Bol cuadrado redondo
Coppetta rotonda-quadrata

SKSRD12 12 cm - 18 cl
4.70" - 6.10 oz

SKSRD11 11 cm - 10 cl
4.35" - 3.40 oz

SKSRD10 10 cm - 7.5 cl
3.95" - 2.55 oz



Small creamer

Petit crémier
Milchkännchen
Lechera pequeña
Bricco da latte piccolo

103JG02 2 cl / 0.70 oz



CUPS & SAUCERS

En

Discover the wide variety of services of cups and saucers created by RAK Porcelain for hot drinks, whose attractive appearance and functionality will meet all of your expectations.

Fr

Découvrez la variété de services de tasses et sous-tasses dédiées aux boissons chaudes créées par RAK Porcelaine pour répondre à toutes vos attentes esthétiques et fonctionnelles.

De

Entdecken Sie die Vielfalt an Geschirr mit Tassen und Untertassen für heiße Getränke, die von RAK Porzellan entworfen wurden, um all Ihre Ansprüche an Ästhetik und Funktionalität zu erfüllen.

Es

Descubra la gran variedad de servicios de tazas y platos para bebidas calientes creados por RAK Porcelain para responder a todas sus expectativas estéticas y funcionales.

It

Scoprite la varietà di servizi di tazze e sotto-tazze per bevande calde create da RAK Porcelain per rispondere a tutte le vostre esigenze estetiche e funzionali.

CLSA01

Universal Saucer

15 cm / 5.90"

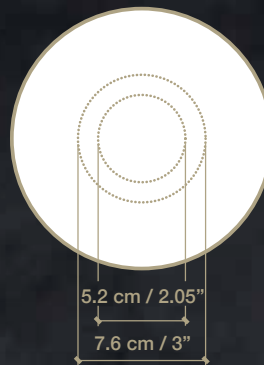

CLSA02
Universal Saucer
 17 cm / 6.70"



SPRP18IN
Allspice
 18 x 14 cm
 7.10 x 5.50"



SPRP24IN
Allspice
 24 x 14 cm
 9.45 x 5.50"



SPRP28IN
Allspice
 28 x 14 cm
 11 x 5.50"



CUPS & SAUCERS

NABUR



BANQUET



FINE DINE



GIRO

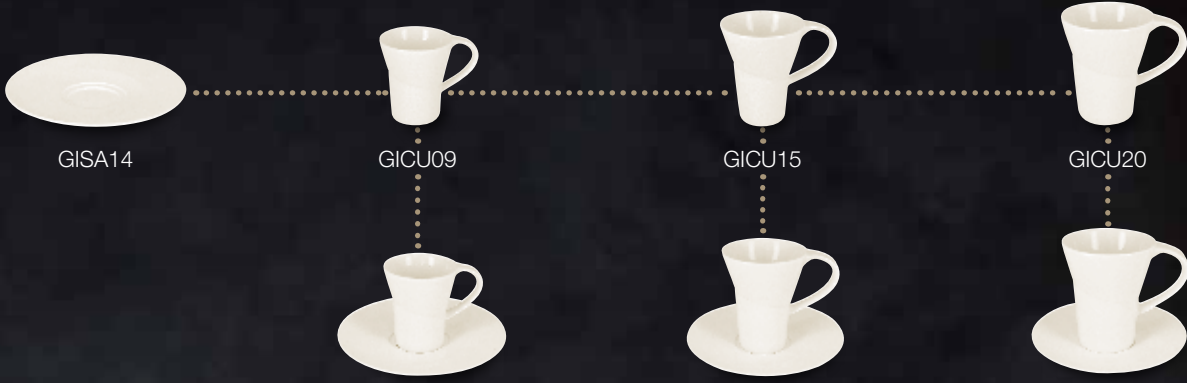

BANQUET (Flora Mug)



CUPS & SAUCERS

CLSA01

Universal Saucer

15 cm / 5.90"
ø 5.2 - 7.6 cm / 2.05 - 3"



CLSA02

Universal Saucer

17 cm / 6.70"
ø 5.2 / 2.05"



SPRP18IN

Allspice

18 x 14 cm / 7.10 x 5.50"
ø 5 - 7.2 cm / 1.95 - 2.85"



BACS01
Banquet



BACS02
Banquet



BACS18
Banquet



BACS30
Banquet



BACU18
Banquet



BACU20
Banquet



BACU23
Banquet



SPRP24IN

Allspice

24 x 14 cm / 9.45 x 5.50"

ø 5 - 6.7 - 9 cm / 1.95 - 2.65 - 3.55"



SPRP28IN

Allspice

28 x 14 cm / 11 x 5.50"

ø 5 - 7 cm / 1.95 - 2.75"



CUPS & SAUCERS

CLSA01

Universal Saucer

15 cm / 5.90"
ø 5.2 - 7.6 cm / 2.05 - 3"



CLSA02

Universal Saucer

17 cm / 6.70"
ø 5.2 / 2.05"



SPRP18IN

Allspice

18 x 14 cm / 7.10 x 5.50"
ø 5 - 7.2 cm / 1.95 - 2.85"



BAGB35
Banquet



BANC22
Banquet



CLCR25
Classic Gourmet



CLCS30
Classic Gourmet



FDCP35
Fine Dine



FDCU09
Fine Dine



FDCU20
Fine Dine



SPRP24IN

Allspice

24 x 14 cm / 9.45 x 5.50"

ø 5 - 6.7 - 9 cm / 1.95 - 2.65 - 3.55"



SPRP28IN

Allspice

28 x 14 cm / 11 x 5.50"

ø 5 - 7 cm / 1.95 - 2.75"



CUPS & SAUCERS

CLSA01

Universal Saucer

15 cm / 5.90"
ø 5.2 - 7.6 cm / 2.05 - 3"



CLSA02

Universal Saucer

17 cm / 6.70"
ø 5.2 / 2.05"



SPRP18IN

Allspice

18 x 14 cm / 7.10 x 5.50"
ø 5 - 7.2 cm / 1.95 - 2.85"



FDCU25
Fine Dine



FDCU30
Fine Dine

FDCU30M1
Fine Dine

FDMU30
Fine Dine



FDTP40
Fine Dine

GDCU09
White gold



GDCU09M
White Gold



SPRP24IN

Allspice

24 x 14 cm / 9.45 x 5 1/2"

ø 5 - 6.7 - 9 cm / 1.95 - 2.65 - 3.55"



SPRP28IN

Allspice

28 x 14 cm / 11 x 5.50"

ø 5 - 7 cm / 1.95 - 2.75"



CUPS & SAUCERS

CLSA01

Universal Saucer

15 cm / 5.90"
ø 5.2 - 7.6 cm / 2.05 - 3"



CLSA02

Universal Saucer

17 cm / 6.70"
ø 5.2 / 2.05"



SPRP18IN

Allspice

18 x 14 cm / 7.10 x 5.50"
ø 5 - 7.2 cm / 1.95 - 2.85"

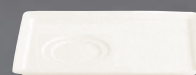

GDCU21
White Gold



GDCU21M
White Gold



LRCU27
Lyra



LRSC27
Lyra



NNCS27
Nano



NNSU25
Nano



NOCU20
Nordic

NOCU20
Nordic

SPRP24IN

Allspice

24 x 14 cm / 9.45 x 5.50"

ø 5 - 6.7 - 9 cm / 1.95 - 2.65 - 3.55"



SPRP28IN

Allspice

28 x 14 cm / 11 x 5.50"

ø 5 - 7 cm / 1.95 - 2.75"

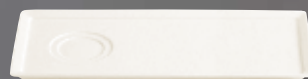

CUPS & SAUCERS

CLSA01

Universal Saucer

15 cm / 5.90"
ø 5.2 - 7.6 cm / 2.05 - 3"



CLSA02

Universal Saucer

17 cm / 6.70"
ø 5.2 / 2.05"



SPRP18IN

Allspice

18 x 14 cm / 7.10 x 5.50"
ø 5 - 7.2 cm / 1.95 - 2.85"



NOMB1
Nordic



NOMG33
Nordic



OPSMG24
Minimax



SKCU23
Ska



SKSM30
Ska



SPCB11
Allspice



SPCU09
Allspice



SPRP24IN

Allspice

24 x 14 cm / 9.45 x 5.50"

ø 5 - 6.7 - 9 cm / 1.95 - 2.65 - 3.55"



SPRP28IN

Allspice

28 x 14 cm / 11 x 5.50"

ø 5 - 7 cm / 1.95 - 2.75"



MAKE SURE
IT'S RAK



CONCEPT AND GRAPHIC DESIGN BY IERACE | DECHMANN + PARTNERS
SPECIAL THANKS TO THE FOLLOWING CHEFS:

YANN CASTANO / SOFITEL LUXEMBOURG EUROPE / LUXEMBOURG
SALVATORE SCOTTO / LE CLERVAUX BOUTIQUE AND DESIGN HOTEL / CLERVAUX / LUXEMBOURG
RUDOLF W. SEGERS / WALDORF ASTORIA / RAS AL KHAIMAH / UAE
JEAN-MICHEL CARRETTE / LES TERRASSES / TOURNUS / FRANCE
THOMAS PONSON / RESTAURANT THOMAS / LYON / FRANCE
CHRISTIAN LHERM / LES 3 DÔMES SOFITEL / LYON / FRANCE
ÉCOLE LENÔTRE / PARIS / FRANCE
ÉRIC GUÉRIN / LA MARE AUX OISEAUX / SAINT JOACHIM / FRANCE
SEBASTIEN CHAMBRU / L'O DES VIGNES / FUISSÉ / FRANCE
YVES CROUZET / HÔTEL LYON OUEST / LYON / FRANCE
MICHEL ROTH / LAURENT WOZNIAK / HÔTEL DU PRÉSIDENT WILSON / GENEVA / SWITZERLAND
RENÉ MATHIEU / CHÂTEAU DE BOURGLINSTER / LUXEMBOURG
KAMAKURA / LUXEMBOURG-VILLE / LUXEMBOURG
LA GAICHEL / EISCHEN / LUXEMBOURG

PHOTO CREDITS:
LUKAS BIDINGER, CYRILLE BOULANGER,
MATTHIEU CELLARD, ETIENNE DELORME, FRANK WEBER

COVER'S PICTURE BY ETIENNE DELORME AND SALVATORE SCOTTO / LE CLERVAUX BOUTIQUE AND DESIGN HOTEL

PRINTED BY: KRÜGER DRUCK + VERLAG

WORLD EDITION 2019

RAK Porcelain LLC
P.O. Box - 30113 - Ras Al Khaimah
United Arab Emirates
T +971 7 223 8905
F +971 7 223 8311
rakporcelain@rakporcelain.com
www.rakporcelain.com

RAK Porcelain Europe S.A.
20, rue de l'Industrie
L-8399 Windhof - Luxembourg
T (+352) 26 36 06 65
F (+352) 26 36 04 65
info@rakporcelaineurope.com
www.rakporcelain.eu

RAK Porcelain USA
595 Route 25A, Suite 17
Miller Place, NY 11764
USA
T- +1 (866)-552-6980
info@rakporcelainusa.com
www.rakporcelainusa.com

Follow us!

